

Chateau d'Ax®

MILANO 1948

HEADQUARTER

Via Nazionale dei Giovi, 159
20823 Lentate sul Seveso (MB) - Italy
info@chateau-dax.it
www.chateau-dax.it

UNITED STATES OFFICES

1838 Eastchester Drive Suite # 106
High Point, North Carolina 27265
www.chateaudax.com



HOME COLLECTION

Over 75 years of inspiration, tradition and innovation.

A MAJOR MILESTONE, A NEW BEGINNING.

Chateau d'Ax becomes a Historic Brand of National Interest. This prestigious accolade is not just a milestone but a new starting point. It inspires us to continue celebrating our history - a symbol of quality and authenticity - with the same passion and dedication that have always set us apart.

75 YEARS

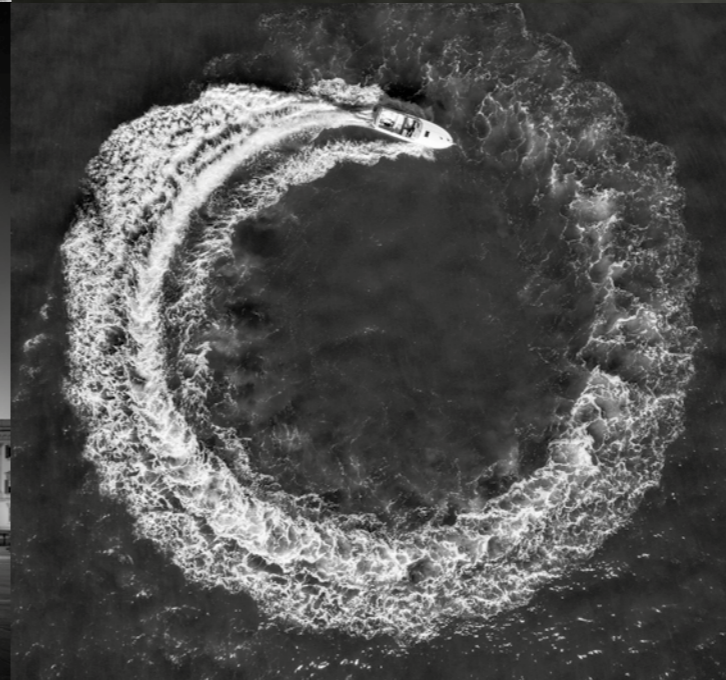

Well-being, relax, comfort and design.

Every Chateau d'Ax project embodies our four core values, focusing on people, their peace of mind and the quality of life in their surroundings. Surroundings that go beyond the concept of a home, extending to everything around us. Because the world is our home.

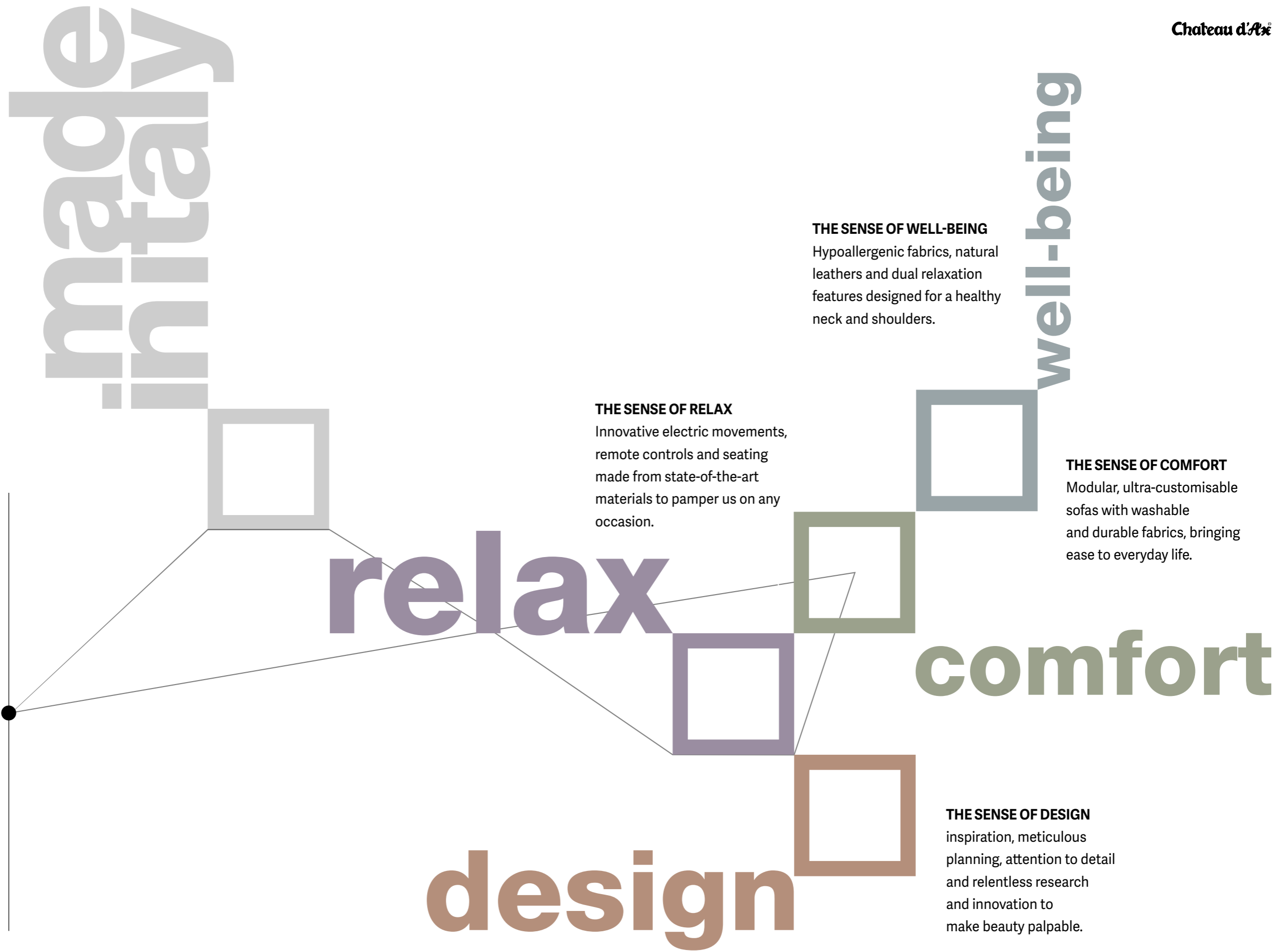

We share our knowledge.

PREMIUM STAIN-RESISTANT FABRICS, SOFT AND FINE LEATHERS, A VAST PALETTE OF COLOURS TO CHOOSE FROM.

The new collections feature Italian-crafted leathers, removable and easy-to-clean fabrics, soft yet elegant microfibre, alongside colours that align with current trends and your personal preferences.

Modern design today, requires ambitious thinking. It's about more than just production cycles, materials, finishes and logistics - it means considering the future of the product. What impact will it have tomorrow? Can it be re-imagined within a circular framework at the end of its life cycle? Our project, "The Circle of Life", was developed with precisely this in mind: to promote sustainable and circular design. This is our starting point, aimed at securing a brighter future for our planet.



hand
made

Relax, there's a whole world to discover.

**ERGONOMIC ELECTRIC
MOVEMENTS, DISCREET
CONTROLS: COMFORT
IS FIRST AND FOREMOST
WELL-BEING.**

Electric, remote-controlled movements and technology at the service of well-being: extendable footrests for stretching out your legs and reclining backrests for total comfort.



Transform your living space into a wellness oasis.

Ergonomics are essential in a sofa to ensure maximum comfort and proper posture during use.

An ergonomic sofa must provide proper back support, making the backrest height and seat depth key elements - a backrest that's too low or a seat that's too deep can lead to discomfort. A good sofa isn't just about aesthetics; it's an investment in physical well-being.

Kaleidos sofa

Available in linear and trapezoidal configurations, fully upholstered in fabric or coordinated with a leather structure and fabric cushions. Cod. 2043



Kaleidos sofa

Available in linear and trapezoidal configurations,
fully upholstered in fabric or coordinated
with a leather structure and fabric cushions.
Cod. 2043

Chateau d'Ax





Ottomons side tables
 Square side tables available in two different sizes, coordinated with the coverings from the Chateau d'Ax collection. Tops available in various finishes and materials. Cod. 2043

Iron table
 Round table with metal base, top with shaped edge, veneered finish, matt lacquered underside and edge. Lazy Susan turntable, 80 cm diameter. Cod. IRON EA



Alice chairs
 Made in the coverings from the Chateau d'Ax collection, with a wooden structure. Cod. ALIC AA



Lampo living wall
 Modular boiserie wall with suspended elements in lacquered and veneered finishes.

Cabaret sideboard

Metal base with modules in veneered finishes and Laminam Statuarietto top.
Cod. 22B



Bricco bookshelf

Free-standing, metal structure and shelves in a melamine finish.





Lambert sofa
*Modular sofa, available in leather, fabric or microfiber
Cod. 38A1*

**THE '70s
STYLE
RETURNS.**

The '70s are back, dominating runways and street style alike, cementing their status as one of today's most beloved trends. The iconic styles of that decade are now enjoying a revival, celebrating the ideals of freedom and vibrant expressiveness typical

of the era's culture. Even in the world of furniture: soft fabrics, fringes, velvets and warm colours blend in a vintage look re-imagined for the modern day. The Lambert sofa embodies this inspiration, featuring rounded forms that give life to modular elements for

customisable compositions: linear, cornered or curved. This isn't mere nostalgia. The '70s style is a declaration of individuality and timeless creativity.



Lambert armchair

Available in leather, fabric or microfibre.

Cod. 38A1



Lambert side table
Painted metal structure
with bronze insert
and veneered or marble tops.



Lambert sideboard

Painted metal base with bronze insert, veneered
structure and marble or Laminam tops.
Coordinated with elements from the Lambert
collection. Cod. L250, L130



Lambert sofa
Modular sofa, available in
leather, fabric or microfiber
Cod. 38A1



America sofa
Modular sofa, available in
fabric or microfiber / leather
Cod. 1870 / 270P



**STYLE, COMFORT
AND PRACTICALITY:
THE PERFECT SOFA.**

Choosing the ideal sofa is all about balancing aesthetics, comfort and practicality. But before making a purchase, it's wise to "measure up" and ensure your space gets the perfect piece!

Space: it is essential to measure the area where the sofa will be placed to avoid ending up with a model that's too large or too small.

Comfort: Test the seating to ensure the backrest and cushions provide proper support and follow the natural contours of your body.

Upholstery: Choose practical materials like fabric or microfiber if you have children or pets, or opt for leather to add a touch of luxury.

Style: Integrating the sofa with the room's design is always a good idea, balancing practicality, colour and your personal taste.

Our suggestion: The America sofa is versatile, modular and features removable covers, adjustable armrests and a variety of sizes to create anything from compact solutions to larger, more intricate compositions.

America sofa
Modular sofa, available in
fabric or microfiber / leather
Cod. 1870 / 270P



Trophee swivel chair
Available in leather, fabric
or microfibre. Cod. P35

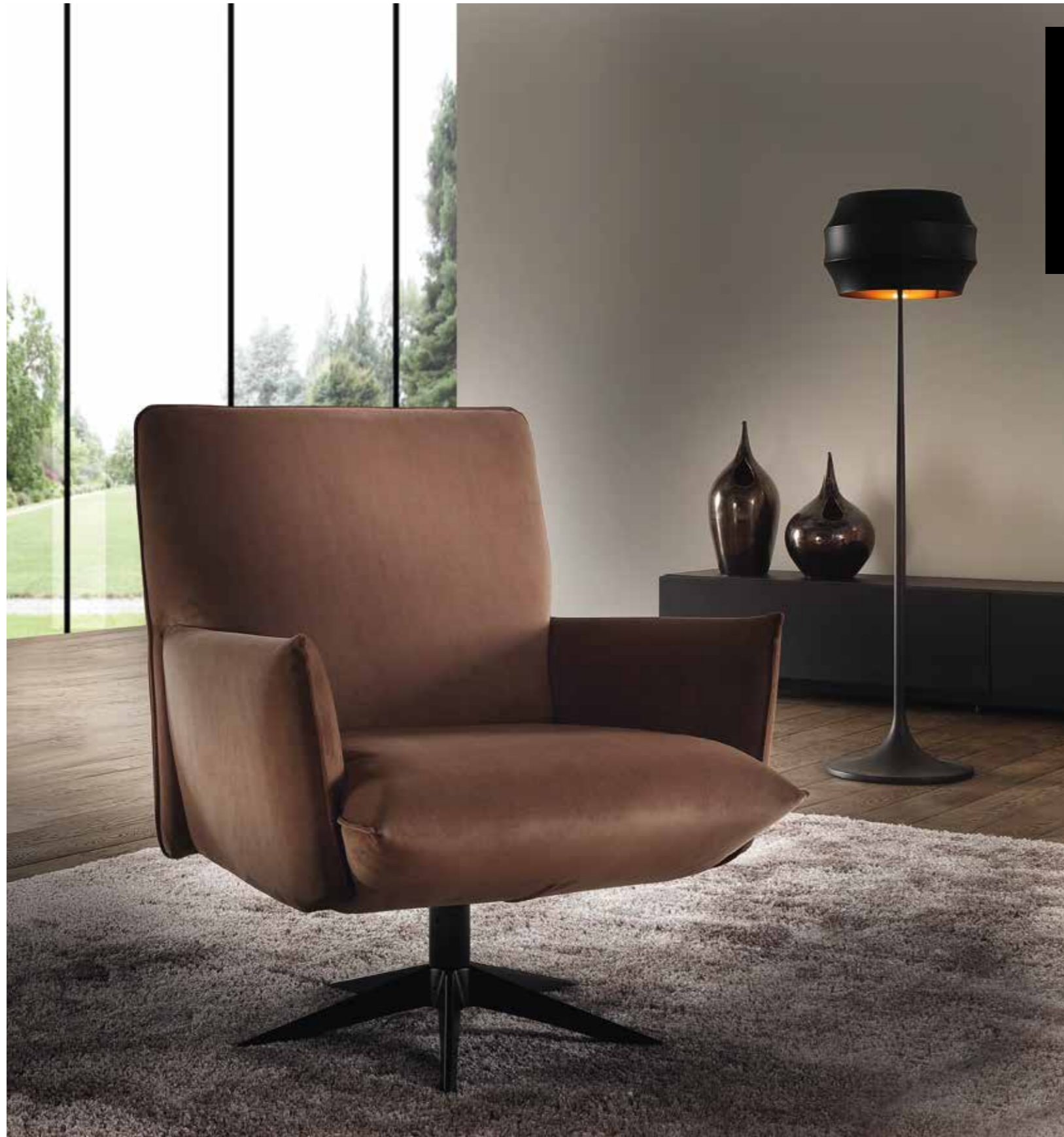

Ibis side table
Side table with painted metal
structure and glass top.
Cod. IBRS



Contemporary design, a tribute to the past.

To understand the origins of the Venus sofa, we must travel back to the 1950s, an era defined by its distinctive shapes and colours. This is because in the world of design, the past continues to inspire the present, with designers increasingly reinterpreting classic forms and styles. The result? Creations that combine nostalgia and modernity, exuding timeless charm with a contemporary edge.



Venus sofa
 Linear sofa, available in leather, fabric or microfiber
 Cod. 3152



Linda chair

Chair with upholstered structure and seat, available in the coverings from the Chateau d'Ax collection.

Obi table

Painted metal structure with an oval-shaped top in annealed glass.

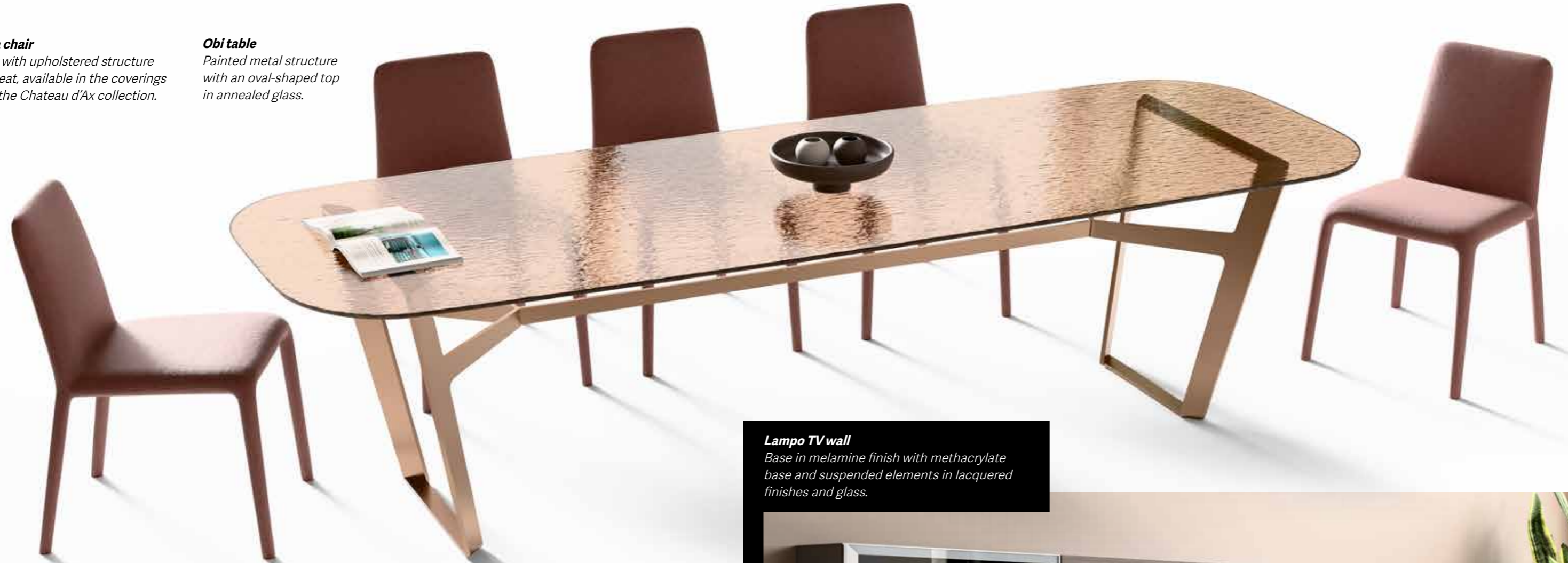

Lampo TV wall

Base in melamine finish with methacrylate base and suspended elements in lacquered finishes and glass.



Tec side tables

Structure in bronze-tinted or smoked annealed glass, top in extra-clear glass.



Roadster sofa

Three seats, modular sofa with relax mechanism, available in leather also.
Cod. 382E 382P

Design Visions, Designer Voices.

Based in the heart of Brianza, Studio Red combines innovation with the traditional craftsmanship synonymous with Made in Italy. Guided by a philosophy that merges functionality with fashion, the firm designs contemporary furnishings with minimalist forms, paying meticulous attention to every detail.

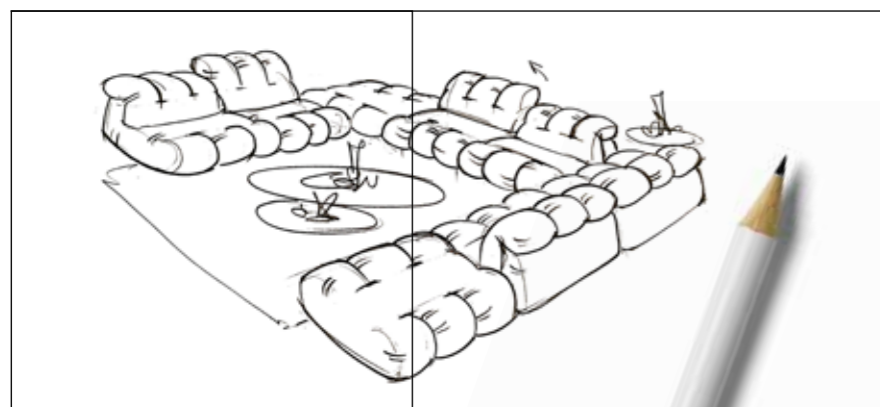

• Inspiration

"Roadster was inspired by the idea of the hand, a symbol of welcome and craftsmanship. It brings people together and unites them."

• Design

"Surprising! Within its modern and soft design lie hidden relaxation mechanisms."

• 2 adjectives

"Embracing and comfortable."

• Features

"It combines the appeal of design with comfort. And offers flexible and modular solutions that are perfect for optimising space."



Roadster sofa

Three seats, modular sofa with
relax mechanism, available in leather also.

Cod. 382E 382P

Chateau d'Ax



Paul side table

Square or rectangular with a painted metal structure and recessed veneered top.



Arco sideboard

Square sideboard with 3D embossed doors in a matt lacquered finish. Cod. A120



Kris Swivel chair

Available in lather, fabric or microfiber Cod. P321



Roadster sofa

Three seats, modular sofa with relax mechanism, available in leather also.
Cod. 382E 382P



The undisputed star of the living room.



The sofa is no longer just a piece of furniture - it has become the true centrepiece of the living room. Taking centre stage, it bridges style and practicality, becoming the focal point around which the entire space revolves. In this light, the Atlantic sofa is the perfect candidate to play this role.

With its elegant lines, artisanal stitching and meticulously finished details on every side, it commands attention in any setting. It has become an unmistakable icon of the Chateau d'Ax style, not merely a place to relax but a reflection of the home's personality and its inhabitants.

Atlantic sofa

Modular sofa, available in
leather, fabric or microfiber.
Cod. 1055

Atlantic sofa
Modular sofa, available in
leather, fabric or microfiber.
Cod. 1055

Chateau d'Azé



Eastway chair

Available in leather, fabric or
microfibre. Cod. P318



Ring side table

Square-based side tables with
a painted metal structure
and double top in Laminam
or mirror finish. Cod. R12S

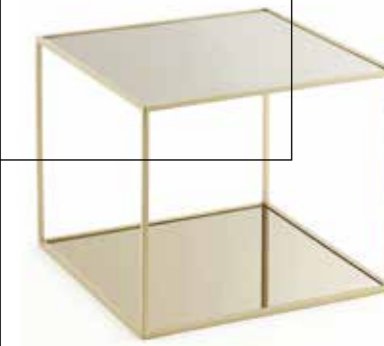

Brick bookshelf

Free-standing vertical version
with painted metal
structure and shelf.

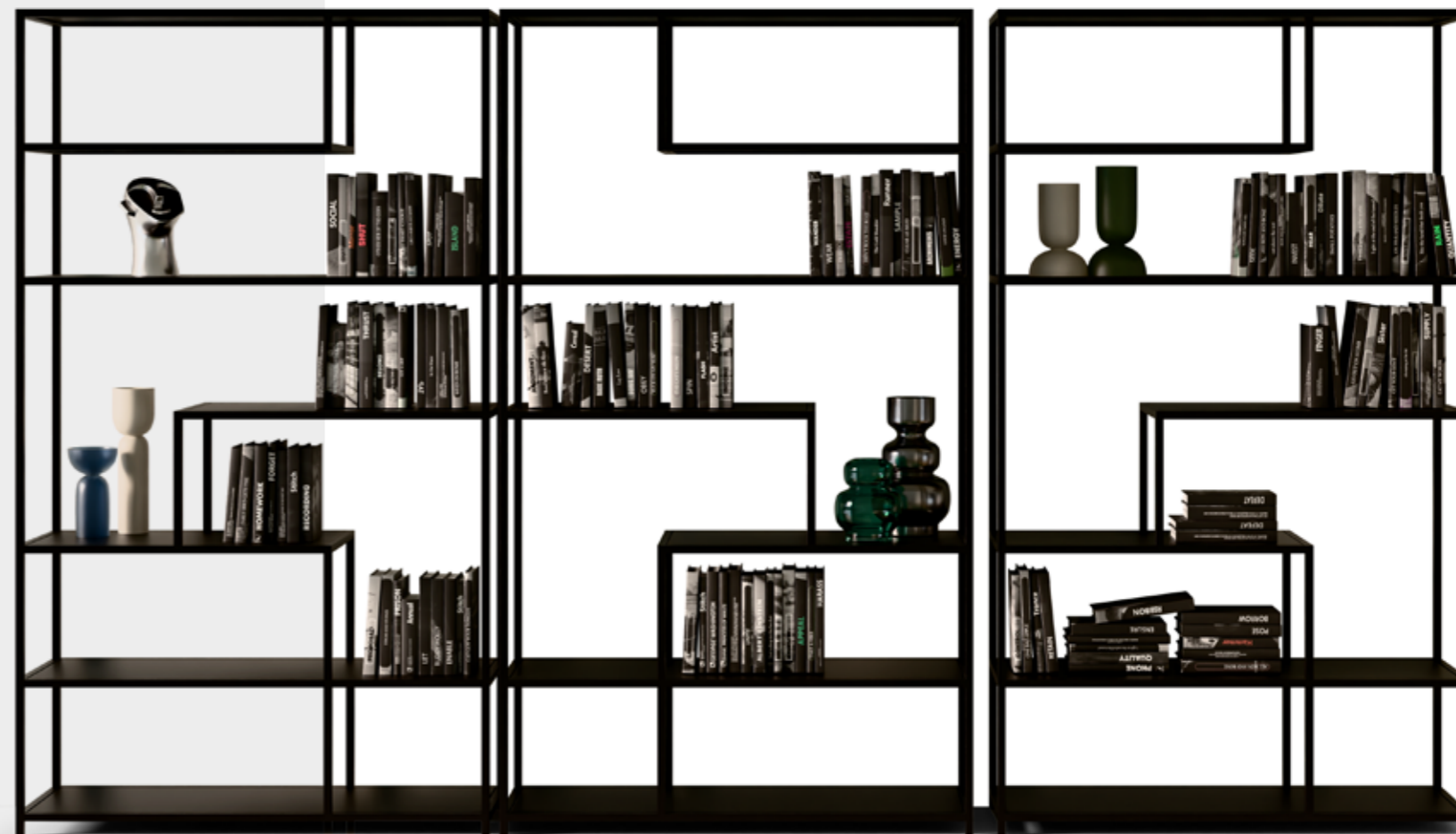

When the design surpasses its creator.

Sometimes, what we create far exceeds our expectations. This is the case for the Avenue sofa, a "simple" piece that has become a true milestone of Chateau d'Ax design. Its striking, soft and bold forms, exude undeniable charisma. It is the natural evolution of expertise and talent - a shared triumph. The design reaches extraordinary heights, allowing the creator to see their work flourish in unexpected and remarkable ways.

Avenue sofa
Modular sofa, available in leather or fabric.
Cod. 3814



Avenue sofa

*Modular sofa, available in leather or fabric.
Cod. 3814*

Chateau d'Azé



Grace chairs
Veneered structure, available
in the coverings from
the Chateau d'Ax collection.

Ibis side table
Side table with painted metal
structure and glass top.



Desko table
Rectangular and extendable with wooden
legs and Laminam top.

Dune sofa
Modular sofa, available in leather or fabric.
Cod. 3800

Chateau d'Arx

Design Visions, Designer Voices.

Born in the 1970s, Corrado Dotti honed his craft with Matteo Thun and Armani Casa before establishing his own studio in Milan in 2007. Specialising in industrial design and interior architecture, he collaborates with numerous furniture and home décor brands.



• 2 adjectives

"Intuitive and versatile."

• Features

"Dune's strength lies in its versatility. With just a few components, it can be configured into various solutions. And similarly, the design, which seamlessly adapts to multiple interior styles."



• Inspiration

"For the design of the Duna sofa, I was inspired by the surface of classic mattresses, as they immediately evoke a sense of well-being and comfort."

• Design

"I would describe it as simple, familiar and understated - it easily adapts to different settings."



HOME COLLECTION

Dune sofa
Modular sofa, available in leather or fabric.
Cod. 3800

Chateau d'Ax



Cliно living

Solution with veneered base and 45° edges, methacrylate feet and shaped wall units in a lacquered finish.



Lena chair

Chair with wooden structure and seat.



Plug table

With central painted metal base comprised of elements that merge in an embrace, and an extendable oval-shaped Laminam top.



Uno side tables

Side tables with oval-shaped central leg and circular top featuring a shaped edge.



Itala bookshelf

Double-sided modular bookshelf with a metal structure, veneered shelf and storage units.

Italy, a timeless source of inspiration for design.

Italy has always been a wellspring of inspiration for design, thanks to its rich artistic and cultural heritage. From Milan, the global capital of style, to the artisanal traditions of smaller towns, the country has profoundly influenced international styles and trends. The blend of innovation and reverence for tradition has birthed design icons renowned for their elegance, practicality and meticulous attention to detail. Just like the Bellagio sofa. Inspired by Lake Como, it celebrates the union of vintage elegance with modern comfort.



Bellagio sofa
 Linear sofa, available in
 leather, fabric or microfiber.
 Cod. 954E



Domino sideboard
Metal base and structure in a lacquered
finish with 45° edge. Cod. MDIN



Paul side table
Square or rectangular with
a painted metal structure
and recessed veneered top.

The good designer's Decalogue.

Dieter Rams, one of the most influential German industrial designers in the world, has inspired generations of creators with his "10 Commandments for Good Design". One of these highlights the aesthetic quality of a product and how essential it is to its usefulness, since everyday objects greatly affect our well-being. The Jardin sofa perfectly embodies this concept: a design inspired by the 1980s, characterised by forms aimed at delivering exceptional comfort. A flawless balance of style and practicality for physical and emotional well-being.

Jardin sofa

*Linear sofa, available in leather, fabric or microfiber.
Cod. 3052*



Jardin sofa

Linear sofa, available in
leather, fabric or microfiber.
Cod. 3052





Fiocco side tables
Painted metal base with tops in painted or acquired metal.



Brick bookshelf
Free-standing vertical version with painted metal structure and shelf.

Desko table
Rectangular and extendable with wooden legs and Laminam top.



Red chair
Chair with an upholstered structure and seat, enveloping backrest, available in the coverings from the Chateau d'Ax collection.

Totem bookshelf
Free-standing with painted metal structure and shelf.



Lion armchair
Structure with metal feet, available in the coverings from the Chateau d'Ax collection.



Festival sofa

*Linear sofa, available in leather, fabric or microfiber.
Cod. 1722*



Speaking of music and well-being, the Festival sofa combines ergonomic design, relaxation movements and a symphony of colours!

TO THE RHYTHM OF WELL-BEING.

Music, as we know, profoundly impacts our well-being, serving as true therapy for both mind and body. Listening to the right track can reduce stress, improve our mood and promote relaxation. Slow, harmonious melodies soothe anxiety, while lively rhythms energise and motivate. The harmonies of sound also boost dopamine production - the "feel-good" hormone - enhancing our sense of happiness.



Desir glass unit

Glass unit with metal structure and smoked glass, internal shelves and lacquered drawers.



Capri side tables

Painted metal base and Laminam top.



Rosb chairs

Wooden legs and structure in the coverings from the Chateau d'Ax collection.

Capri table

Painted metal base and Laminam top.

Silhouette sofa

Modular sofa with relax mechanism,
available in leather, fabric or microfiber.
Cod. 1044

Chateau d'Ax®

The art of creating spaces that reflect who you are.



Ever looked around your home and felt something was missing? Sometimes, it's simply a matter of colour. And when it comes to patterns and palettes, the Silhouette sofa knows exactly what it's doing! Colour holds incredible power in defining the atmosphere of a room. A bold wall colour can become the focal point of a space, adding character and depth. How about a rich navy blue in the living room for a touch of elegance? Or perhaps sage green in the bedroom for a soothing vibe? If the idea of painting feels daunting, why not try wallpaper? With modern designs and easy application techniques, you can create a stunning effect in just a few hours.

Silhouette sofa

Modular sofa with relax mechanism,
available in lather, fabric or microfiber.

Cod. 1044



Silhouette sofa

Modular sofa with relax mechanism,
available in leather, fabric or microfiber.

Cod. 1044

Chateau d'Ax



Tavolino Gabbia
in metallo anodizzato con diverse
soluzioni di piano Cod. T456



Golden sofa
Modular sofa, available in
eather, fabric or microfiber.
Cod. 2220

The sustainable lightness of home.

A home that feels airy, welcoming and relaxing requires thoughtful choices that create a sense of space and brightness. Here are a few tips:

• **Light colours:**
opt for neutral or pastel tones on the walls, such as white, beige or light grey, to visually expand spaces and reflect natural light.

• **Minimalist furniture:**
choose simple, lowing designs like the Golden sofa, which is linear and modern, with a delicate yet inviting style.

• **Natural light:**
enhance brightness with sheer, transparent curtains or mirrors to amplify the light.

• **Natural materials:**
use materials such as light wood, glass and rattan, which bring a sense of freshness and lightness to the space.

• **Essential decorations:**
pare back decorative objects in favour of a few well-selected pieces, such as indoor plants or ceramic accents.

Golden sofa
Modular sofa, available in
eather, fabric or microfiber.
Cod. 2220

Chateau d'Ax



Terin sofa

Modular sofa with electric sliding backrest,
available in leather, fabric or microfiber.

Cod. 3780/3781

**Down to the
last detail.**

Movimento avant recule



One of the principles of great design is that nothing should feel arbitrary or left to chance. Care and precision in the design process show respect for those who will eventually purchase the product. Steve Jobs, one of the great pioneers of modern technology, famously considered even the design of the internal circuits in his computers, ensuring every product was as beautiful inside as it was outside. In our own way, the Terin sofa is a testament to this philosophy, with its meticulous attention to detail enhancing both its concept and form.

Terin sofa
Modular sofa with electric sliding backrest,
available in leather, fabric or microfiber.
Cod. 3780/3781

Chateau d'Ax



H O M E C O L L E C T I O N

Long Island sofa
Modular sofa, available in leather,
fabric or microfiber.
Cod. 4001-4001S/4002-4002S

Chateau d'Ax

Inspiration from Canada.



Toronto-born Frank O. Gehry is one of the most innovative and influential architects of our time. Renowned for his bold, iconic creations, he has revolutionised the world of architecture with his unique approach, characterised by sculptural forms and inventive use of materials. Famed for transforming architectural function into art, his buildings defy conventions and captivate both audiences and critics.

With a career spanning decades of innovation, his work continues to influence and inspire the global architectural landscape. In keeping with the concept of "usable aesthetics", our Long Island sofa feels perfectly at ease: modern, versatile, functional and highly modular in its design, it is available in both classic linear and curved configurations.

Long Island sofa
Modular sofa, available in leather,
fabric or microfiber.
Cod. 4001-4001S/4002-4002S

Chateau d'Ax



Long Island sofa
Modular sofa, available in leather,
fabric or microfiber.
Cod. 4001-4001S/4002-4002S



When space gives way to imagination.

Decorating the living room with creativity is an opportunity to express personality and flair. Playing with colours, daring with bold and unexpected combinations, can bring energy to the space. Multifunctional furniture and a mix of styles - for instance, combining vintage pieces with modern elements - make the space more dynamic. Walls can be enhanced with a gallery of artwork, mirrors or unique wallpaper. The key is always to blend harmony with boldness, creating a living room that feels both unique and welcoming.



Wonka sofa
modular sofa with relax mechanism,
available in leather, fabric or microfiber.
Cod. 385E

The Wonka sofa by Chateau d'Axi combines imagination with comfort, featuring a sophisticated design, generously padded seats, and adjustable footrests and headrests with independent electric mechanisms.

Wonka sofa
modular sofa with relax mechanism,
available in leather, fabric or microfiber.
Cod. 385E

Chateau d'Arce



Prin armchair

Wooden legs, available
in the coverings
from the Chateau d'Ax collection.



Lampo living

Veneered boiserie with matt
lacquered suspended modules,
metal shelves with LED lighting.



Wonka side tables

Tubular structure in lead-painted
metal with a marble
and veneered top. Cod. RS2B/C

Wonka table

Tubular structure in lead-painted metal with a rectangular travertine top.
Cod. RS2A



Marcela accent chair

Legs available in various wood finishes, made in the coverings from the Chateau d'Ax collection.

Wonka pouffe side tables

Round pouffes available in the coverings from the Chateau d'Ax collection with wood, marble or glass top.



Domino Giro

Swivel modules with veneered and lacquered finishes, featuring a display case and drawer, 45° edges.

Oyster sofa

Modular sofa with relax mechanism,
available in leather, fabric or microfiber.
Cod. 386E

Design Visions, Designer Voices.

Based in the heart of Brianza,
Studio Red combines
innovation with the traditional
craftsmanship synonymous
with Made in Italy.

Guided by a philosophy
that merges functionality
with fashion, the firm designs
contemporary furnishings
with minimalist forms,
paying meticulous attention
to every detail.



• Inspiration

*"The circularity of functions,
typical of Walter Gropius' Bauhaus
movement. Curved lines
embrace each other in a play
of materials: wood,
metal, leather and fabric."*

• Design

*"Timeless, with understated
elegance and generous proportions.
The collection is enriched by
tailored details that embody true
Made in Italy craftsmanship."*

• In two words

*"Formal precision, exceptional
comfort."*

• Features

*"Welcoming with its soft
padding, modularity to adapt
to endless design needs,
and clean lines."*



Oyster sofa

Modular sofa with relax mechanism,
available in leather, fabric or microfiber.
Cod. 386E

Chateau d'Ax®





Oystis side table

Tubular structure in lead- or gunmetal-painted metal with Chateau d'Ax leather inserts. Veneered, lacquered or Chateau d'Ax leather-upholstered tops.

Domino living

TV unit with veneered base and methacrylate feet, suspended modules with 45° edges, wall units in matt lacquered and glass finish.



Brick bookshelf

Free-standing horizontal version with painted metal structure and shelf.



Tempo sideboard

Metal base, veneered carcass with lacquered modules and open housing space.



Paros chairs

Available in the coverings from the Chateau d'Aix collection, wooden structure.

Poliedro table

Structure available in painted or lacquered metal, rectangular top with rounded corners and shaped edge, veneered or Laminam finish.

What is the shape of the future?

AI-designed creations are revolutionising creativity, combining human intuition with machine precision. Using advanced algorithms, AI can generate innovative designs, optimise processes and customise solutions in real time. This collaboration expands creative possibilities, offering new perspectives and transcending the limits of traditional design. This is how Shibuya was born - the product of a creative process that merges artificial intelligence with artisanal expertise, refined by designers to achieve the perfect balance of beauty and comfort.



Shibuya sofa

*Linear sofa, available in leather, fabric or microfiber.
Cod. 3823*



Shibuya side table

Rectangular or round, available
with smoked or annealed
glass top, lead-painted metal feet.
Cod. R150-R151



Sofy armchair

Tubular metal structure available
in the coverings from
the Chateau d'Ax collection.



**When
minimalism
becomes
grand.**

Suzuka sofa

*Modular sofa with sliding backrest,
available in leather, fabric or microfiber.
Cod. 2327/2328*



Airiness, no decoration, limited colours and materials, lighting that fills the space, and meticulous attention to detail. These are the hallmarks of minimalist architecture, exemplified by Frank Lloyd Wright. His "Fallingwater" house and the Guggenheim Museum

in New York are just some of the masterpieces he created, which continue to inspire architects and designers worldwide. Suzuka, too, is a product of this movement: a sofa with clean, modern lines and a strong personality that complements rather

than overpowers the surrounding space. Its extreme comfort, enhanced by sliding or adjustable backrests, is truly remarkable.

Suzuka sofa
Modular sofa with sliding backrest,
available in leather, fabric or microfiber.
Cod. 2327/2328



Suzuka sofa
Modular sofa with sliding backrest,
available in leather, fabric or microfiber.
Cod. 2327/2328

Chateau d'Ax



made in Italy

“
”
OVER 350 RETAIL STORES IN 40 COUNTRIES AND EXPORTS TO 80 COUNTRIES ACROSS 5 CONTINENTS

well-being

relax

comfort

design

Chateau d'Axx®

2043
KALEIDOS

RIVESTIMENTO: pelle, tessuto e microfibra, non sfoderabile
FUSTO: fusto realizzato in pannelli di truciolare e multistrato classe E1; assemblato con listelli in abete e/o faggio massello. Le parti della struttura portante sono imbullonate
IMBOTTITURA SCHIENALE: fibra di poliestere
IMBOTTITURA SEDUTA: poliuretano espanso e resinato
IMBOTTITURA BRACCIOLI: poliuretano espanso e resinato
SOSPENSIONI SCHIENALE: pannello in faesitee
SOSPENSIONI SEDUTA: pannello multistrato
PIEDINO: piedino in metallo nero

COVERING: leather and fabric. Not removable
FRAME CONSTRUCTION: hardwood load bearing rails, high density particle board, glued, screwed and stapled
BACK CUSHIONS: hardboard
SEAT INTERIORS: polyester
BACK CUSHIONS: Polyurethane foam and resin material
SEAT SUSPENSIONS: hardboard
FEET: black metal feet
UNDER BOTTOM: dust cover



70 cm
30 inches



96 cm
35 inches

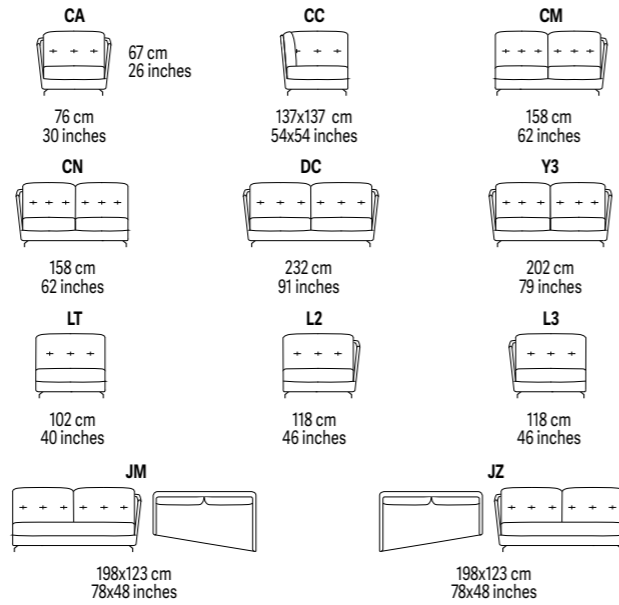

38A1
LAMBERT

RIVESTIMENTO: pelle, tessuto e microfibra, non sfoderabile
FUSTO: fusto realizzato in pannelli di truciolare e multistrato classe E1; assemblato con listelli in abete e/o faggio massello. Le parti della struttura portante sono imbullonate
SOSPENSIONI SEDUTA: cinghie elastiche
SOSPENSIONI SCHIENALE: cinghie elastiche
IMBOTTITURA SEDUTA: poliuretano espanso + strato di resinato
IMBOTTITURA SCHIENALE: poliuretano espanso + strato di resinato
PIEDINO: Sostegno in plastica H4cm
ALTRE INFORMAZIONI: Poltrona con seduta girevole

COVERING: leather and fabric; not removable cover
FRAME CONSTRUCTION: hardwood load bearing rails, high density particle board, glued, screwed and stapled
BACK CUSHIONS: polyurethane foam and resin material
SEAT INTERIORS: polyurethane foam resin material
BACK SUSPENSIONS: webbings (elastic belts)
SEAT SUSPENSIONS: webbings (elastic belts)
SEAT: plastic feet H4 cm
OTHER INFORMATION: swivel armchair



78 cm
31 inches

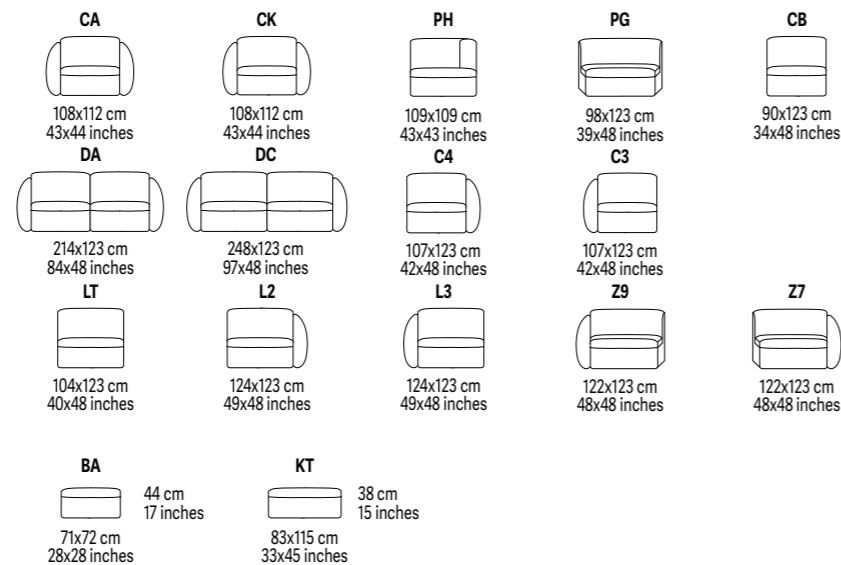

270P/187
AMERICA

RIVESTIMENTO: pelle o tessuto, disponibile in versione sfoderabile e non sfoderabile
FUSTO: pannelli di fibra di legno e multistrato classe E1, assemblato con listelli in abete e/o faggio massello; le parti della struttura portante sono imbullonate
IMBOTTITURA SCHIENALE: poliuretano espanso
IMBOTTITURA SEDUTA: poliuretano espanso
SOSPENSIONI SCHIENALE: cinghie elastiche
SOSPENSIONI SEDUTA: cinghie elastiche
PIEDINO: piedino nero in legno h. 7 cm
SOTTO DIVANO: copertura parapolvere
INFORMAZIONI AGGIUNTIVE: bracciolo reclinabile

COVERING: leather and fabric, removable and not removable covers versions available
FRAME CONSTRUCTION: hardwood load bearing rails, high density particle board, glued, screwed and stapled
BACK CUSHIONS: polyurethane foam
SEAT INTERIORS: polyurethane foam
BACK SUSPENSIONS: webbings (elastic belts)
SEAT SUSPENSIONS: webbings (elastic belts)
FEET: wooden feet - black h. 7 cm
UNDER BOTTOM: dust cover
OTHER INFORMATION: adjustable armrest



90 cm
35,43 inches



94 cm
37 inches

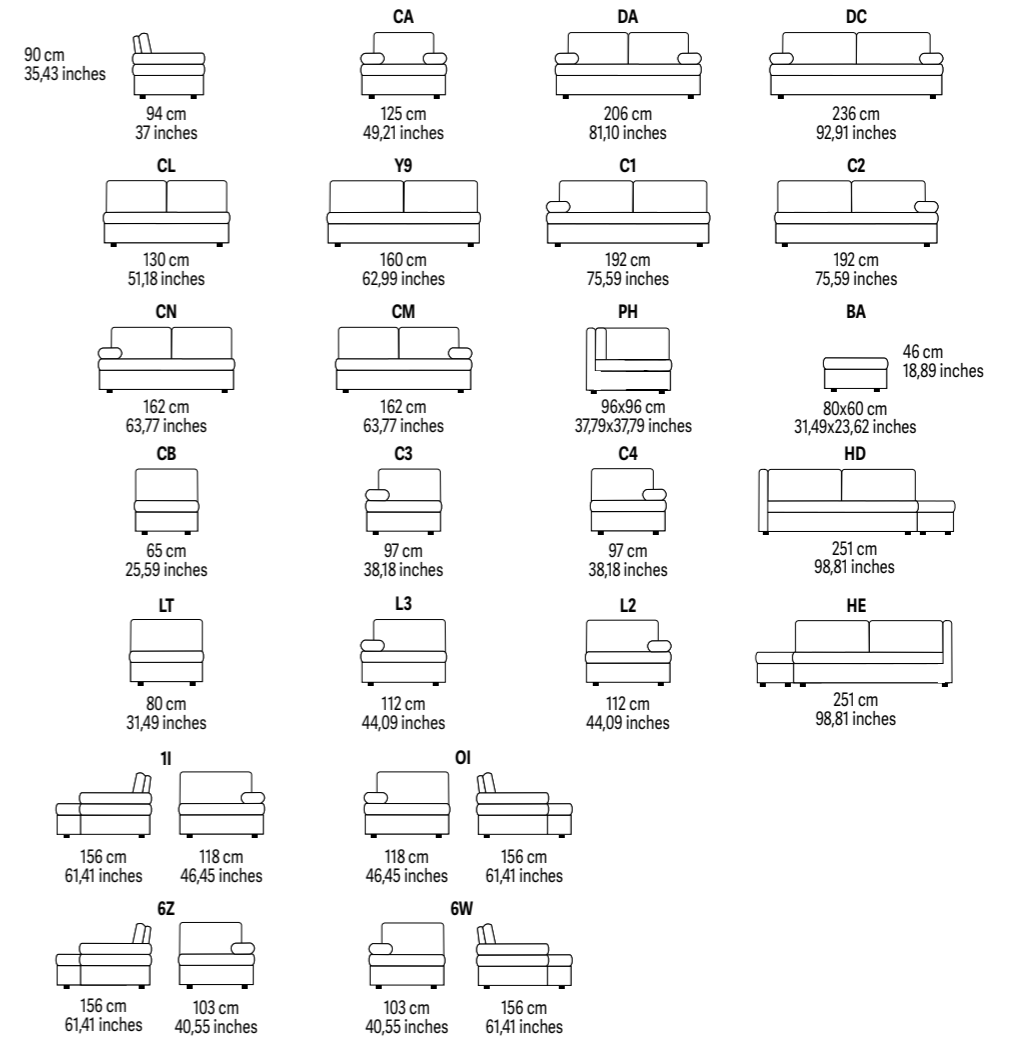

3152 VENUS

RIVESTIMENTO: pelle, tessuto e microfibra, non sfoderabile
FUSTO: fusto realizzato in pannelli di truciolare e multistrato classe E1; assemblato con listelli in abete e/o faggio massello. Le parti della struttura portante sono imbullonate
SOSPENSIONI SEDUTA: cinghie elastiche
SOSPENSIONI SCHIENALE: cinghie elastiche
IMBOTTITURA SEDUTA: poliuretano espanso
IMBOTTITURA SCHIENALE: fibra di poliestere
IMBOTTITURA BRACCIOLO: poliuretano espanso
PIEDINO: sostegno in plastica color nero

COVERING: leather, fabric and microfibre; not removable cover
FRAME CONSTRUCTION: hardwood load bearing rails, high density particle board, glued, screwed and stapled
BACK CUSHIONS: polyester fiber
SEAT INTERIORS: polyurethane foam
BACK SUSPENSIONS: webbings (elastic belts)
SEAT SUSPENSIONS: webbings (elastic belts)
FEET: plastic feet

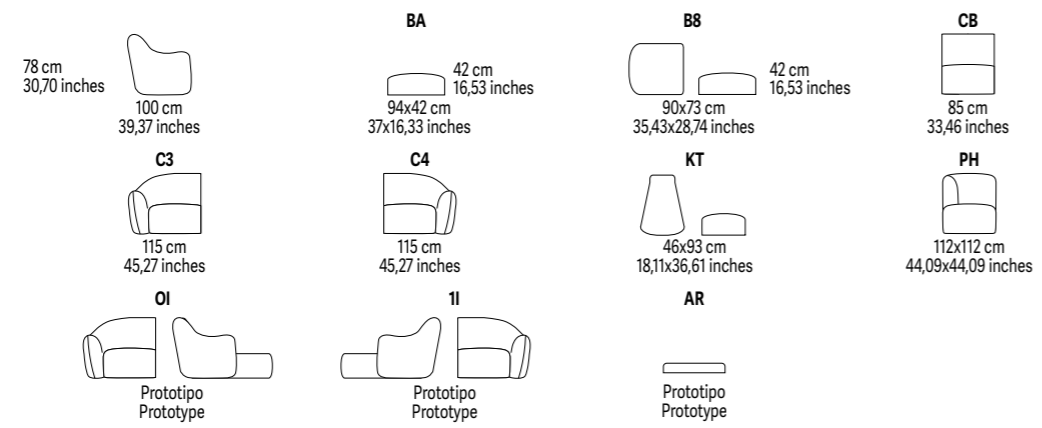

1055 ATLANTIC

RIVESTIMENTO: pelle, tessuto o microfibra; non sfoderabile
FUSTO: legno massello, rinforzato con pannelli di particelle
SOSPENSIONI SEDUTA: cinghie elastiche
SOSPENSIONI SCHIENALE: cinghie elastiche
IMBOTTITURA SEDUTA: poliuretano espanso
IMBOTTITURA SCHIENALE: fibra poliestere
PIEDINO: piedino in legno-plastica rivestito in metallo h. 6,3 cm
SOTTO DIVANO: copertura parapolvere

COVERING: leather, microfibre and fabric; not removable cover
FRAME CONSTRUCTION: solid wood, reinforced with particle board
SEAT SUSPENSIONS: webbings (elastic belts)
BACK SUSPENSIONS: webbings (elastic belts)
SEAT INTERIORS: polyurethane foam
BACK CUSHIONS: polyester fiber
FEET: plastic-wood, metal coated h. 6,3 cm
UNDER BOTTOM: dust cover

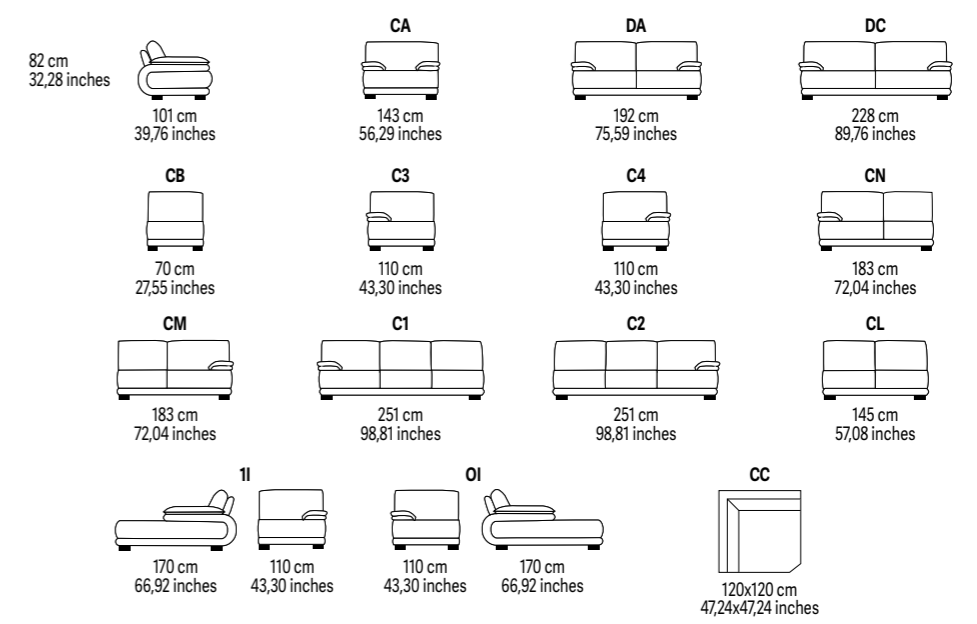

382E ROADSTER

RIVESTIMENTO: pelle, tessuto e microfibra, non sfoderabile
FUSTO: fusto realizzato in pannelli di truciolare e multistrato classe E1; assemblato con listelli in abete e/o faggio massello. Le parti della struttura portante sono imbullonate
SOSPENSIONI SEDUTA: cinghie elastiche
SOSPENSIONI SCHIENALE: cinghie elastiche
IMBOTTITURA SEDUTA: poliuretano espanso + fibra di poliestere
IMBOTTITURA SCHIENALE: poliuretano espanso + fibra di poliestere
PIEDINO: sostegno in plastica color nero

COVERING: leather, fabric and microfibre; not removable cover
FRAME CONSTRUCTION: hardwood load bearing rails, high density particle board, glued, screwed and stapled
BACK CUSHIONS: polyurethane foam + polyester fiber
SEAT INTERIORS: polyurethane foam + polyester fiber
BACK SUSPENSIONS: webbings (elastic belts)
SEAT SUSPENSIONS: webbings (elastic belts)
FEET: plastic feet

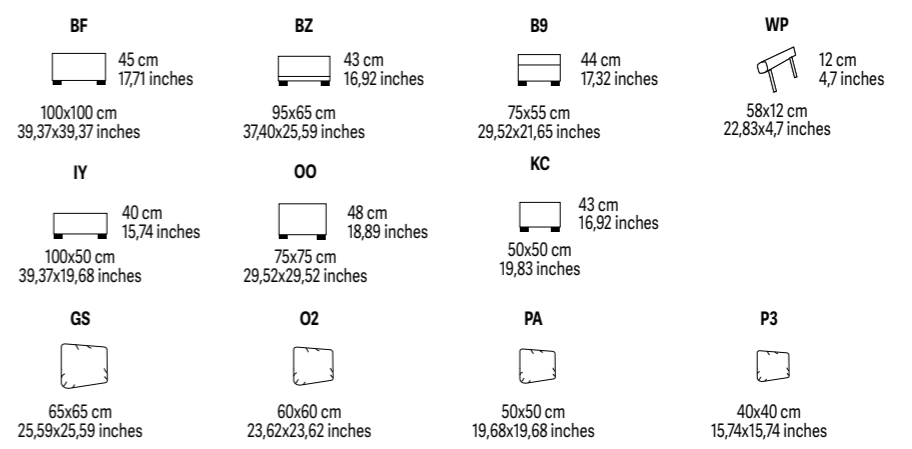
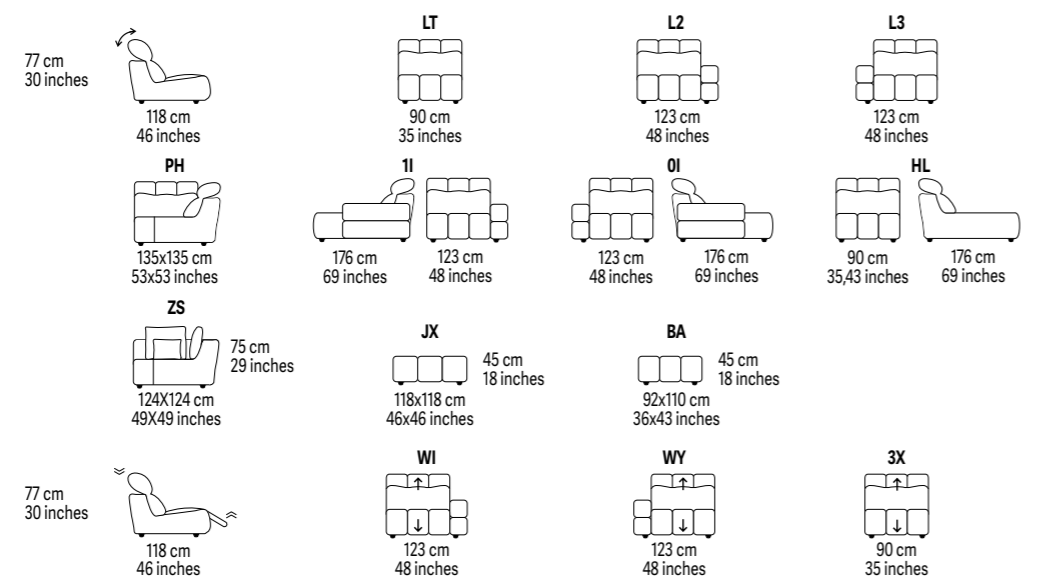

Le dimensioni sono indicative e possono subire modifiche / All dimensions are approximate and for guidance only
 Le cuciture nelle versioni in pelle possono variare rispetto alle versioni in tessuto / Stitchings in leather versions may vary compared to fabric ones

3814 AVENUE

RIVESTIMENTO: pelle o tessuto; non sfoderabile
FUSTO: pannelli di fibra di legno e multistrato classe E1, assemblato con listelli in abete e/o faggio massello; le parti della struttura portante sono imbullonate
IMBOTTITURA SCHIENALE: poliuretano espanso e misto piuma
IMBOTTITURA SEDUTA: poliuretano espanso e misto piuma
IMBOTTITURA BRACCIOLO: poliuretano espanso e misto piuma
SOSPENSIONI SCHIENALE: cinghie elastiche
SOSPENSIONI SEDUTA: cinghie elastiche
PIEDINO: nero in plastica h. 4 cm
SOTTO DIVANO: copertura parapolvere

COVERING: leather and fabric; not removable cover
FRAME CONSTRUCTION: hardwood and pinewood, high density particle board, glued, screwed and stapled
BACK CUSHIONS: polyurethane foam and mixed feather
SEAT INTERIORS: polyurethane foam and mixed feather
ARM INTERIORS: polyurethane foam and mixed feather
BACK SUSPENSIONS: webbings (elastic belts)
SEAT SUSPENSIONS: webbings (elastic belts)
FEET: black plastic feet h. 4 cm
UNDER BOTTOM: dust cover

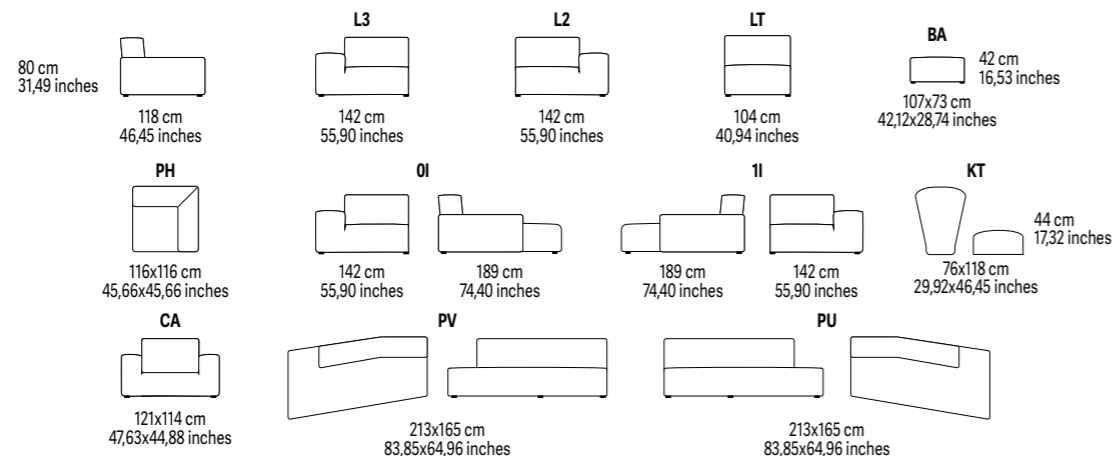

3800 DUNE

RIVESTIMENTO: pelle, tessuto e microfibra, non sfoderabile
FUSTO: fusto realizzato in pannelli di truciolare e multistrato classe E1; assemblato con listelli in abete e/o faggio massello. Le parti della struttura portante sono imbullonate
SOSPENSIONI SEDUTA: cinghie elastiche
SOSPENSIONI SCHIENALE: cinghie elastiche
IMBOTTITURA SEDUTA: poliuretano espanso e resinato
IMBOTTITURA SCHIENALE: poliuretano espanso e resinato
IMBOTTITURA BRACCIOLO: poliuretano espanso e resinato
PIEDINO: piedino in plastica nero H 6cm
ALTRE INFORMAZIONI: Cuscini schienale optional, da ordinare separatamente come segue:
L2-L3-LT: 1 VT oppure 2 *C
C3-C4-CB: 1 QH oppure 1 *C
Cuscino VT: cuscino trapuntato 115x55 per elementi maxi
Cuscino QH: cuscino trapuntato 85x55 per elementi piccoli
Cuscino *C: cuscino liscio 80x80

COVERING: leather and fabric. Not removable
FRAME CONSTRUCTION: hardwood load bearing rails, high density particle board, glued, screwed and stapled
BACK CUSHIONS: polyurethane foam and resin material
SEAT INTERIORS: polyurethane foam and resin material
BACK SUSPENSIONS: hardboard
SEAT SUSPENSIONS: webbings (elastic belts)
ARM INTERIORS: polyurethane foam and resin material
FEET: black plastic feet H6 cm
UNDER BOTTOM: dust cover
SUGGESTED BACK PILLOWS:
L3/L2-LT: 1 VT or 2 *C
C3/C4-CB: 1 QH or 1 *C
OTHER INFORMATION:
Pillows VT: quilted cushion 115x55 for maxi elements
Pillows QH: quilted cushion 85x55 for small elements
Pillows *C: pillow 80x80

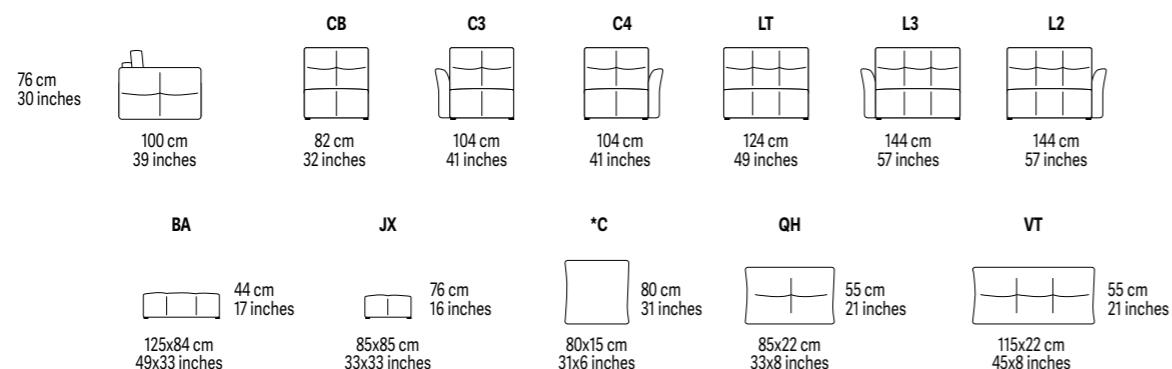

954E BELLAGIO

RIVESTIMENTO: pelle o tessuto; non sfoderabile
FUSTO: pannelli di fibra di legno e multistrato classe E1, assemblato con listelli in abete e/o faggio massello; le parti della struttura portante sono imbullonate
IMBOTTITURA SCHIENALE: poliuretano espanso e misto piuma
IMBOTTITURA SEDUTA: poliuretano espanso e misto piuma
SOSPENSIONI SCHIENALE: cinghie elastiche
SOSPENSIONI SEDUTA: molla Nosag
PIEDINO: piedini in metallo cromati color canna di fucile h. 11 cm
SOTTO DIVANO: copertura parapolvere (tranne per la seduta degli elementi con meccanismo relax)
INFORMAZIONI AGGIUNTIVE: modello con relax elettrico; poggiatesta reclinabili

COVERING: leather and fabric; not removable cover
FRAME CONSTRUCTION: hardwood load bearing rails, high density particle board, glued, screwed and stapled - iron frame in the armrest
BACK CUSHIONS: polyurethane foam and mixed feather
SEAT INTERIORS: polyurethane foam and mixed feather
BACK SUSPENSIONS: webbings (elastic belts)
SEAT SUSPENSIONS: Nosag
FEET: chromes metal feet gun-barrel grey finish h. 11 cm
UNDER BOTTOM: dust cover (except seat of elements with recliner mechanism)
OTHER INFORMATION: model with electric relax; adjustable headrests

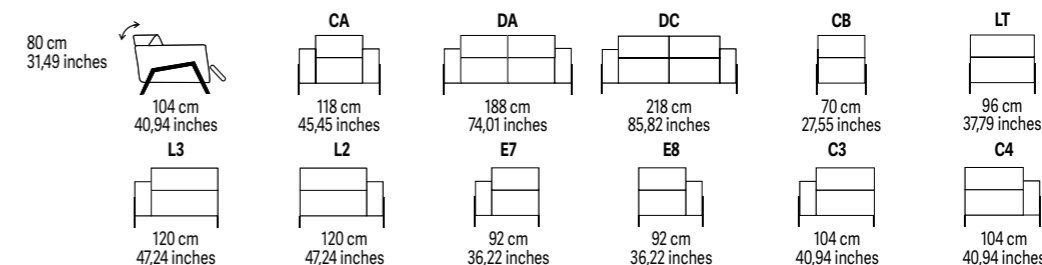

ELEMENTI CON MECCANISMO ELETTRICO POGGIAGAMBE ELEMENTS WITH ELECTRICAL RECLINER MECHANISM FOR LEGREST

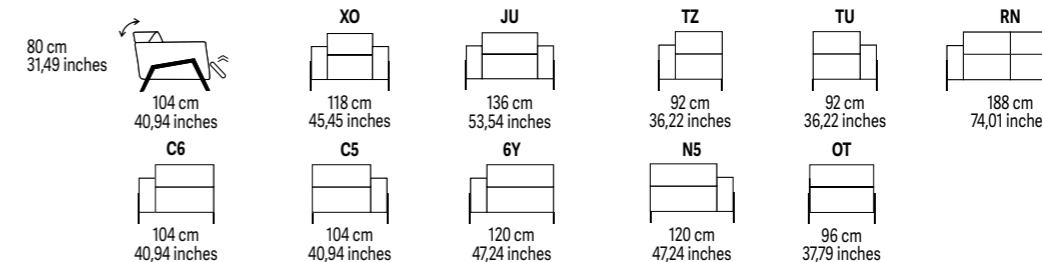

ELEMENTI CON 2 MECCANISMI ELETTRICI POGGIAGAMBE - POGGIATESTA ELEMENTS WITH 2 INDEPENDENT ELECTRICAL MECHANISMS FOR LEGREST AND HEADREST

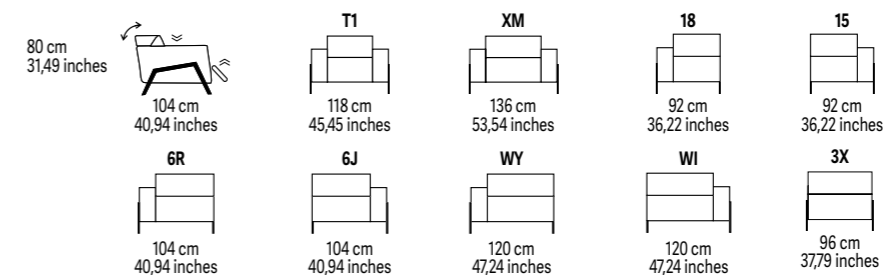

3052 JARDIN

RIVESTIMENTO: pelle, tessuto e microfibra, non sfoderabile
FUSTO: Fusto realizzato in pannelli di truciolare e multistrato classe E1; assemblato con listelli in abete e/o faggio massello. Le parti della struttura portante sono imbullonate
IMBOTTITURA SEDUTA: poliuretano espanso e strato di poliester
IMBOTTITURA SCHIENALE: poliuretano espanso e strato di poliester
PIEDINO: piedino in plastica nero H 3cm

COVERING: leather and fabric
FRAME CONSTRUCTION: hardwood load bearing rails, high density particle board, glued, screwed and stapled
BACK CUSHIONS: polyurethane foam and polyester fiber layer
SEAT INTERIORS: polyurethane foam and polyester fiber layer
SEAT INTERIORS: polyurethane foam and polyester fiber layer
SUSPENSIONS: no suspensions
SEAT: plastic feet H 3cm
UNDER BOTTOM: dust cover

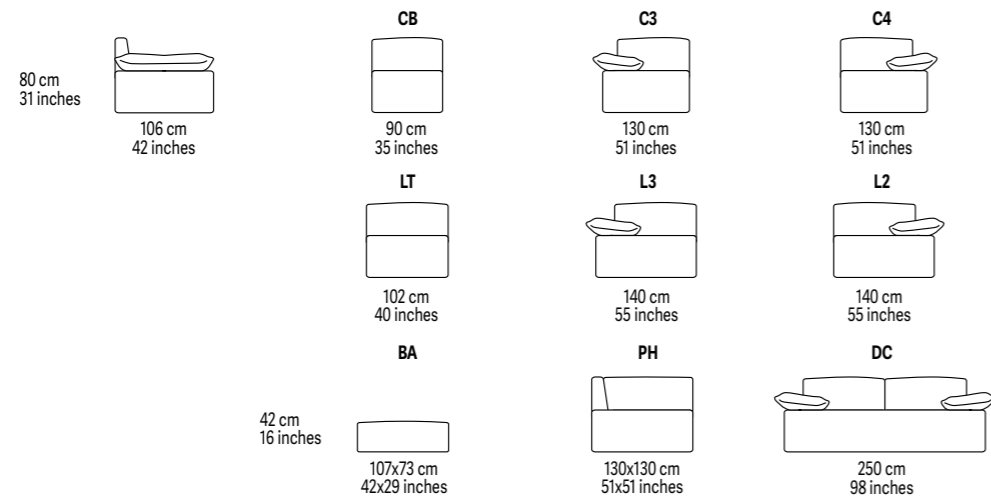

1044 SILHOUETTE

RIVESTIMENTO: pelle, tessuto o microfibra; non sfoderabile
FUSTO: pannelli di fibra di legno e multistrato classe E1, assemblato con listelli in abete e/o faggio massello; le parti della struttura portante sono imbullonate
SOSPENSIONI SCHIENALE: cinghie elastiche
SOSPENSIONI SEDUTA: cinghie elastiche
IMBOTTITURA SCHIENALE: poliuretano espanso
IMBOTTITURA SEDUTA: poliuretano espanso
PIEDINO: elementi fissi, piedino nero in plastica h. 3,5 cm
SOTTODIVANO: copertura parapolvere
INFORMAZIONI AGGIUNTIVE: relax elettrico in opzione

COVERING: leather, microfibre, fabric; not removable cover
FRAME CONSTRUCTION: hardwood load bearing rails, high density particle board, glued, screwed and stapled
BACK SUSPENSIONS: webbings (elastic belts)
SEAT SUSPENSIONS: webbings (elastic belts)
BACK CUSHIONS: polyurethane foam
SEAT INTERIORS: polyurethane foam
FEET: static elements: black plastic feet h. 3,5 cm
UNDER BOTTOM: dust cover for static elements
OTHER INFORMATIONS: model with electric relax in option

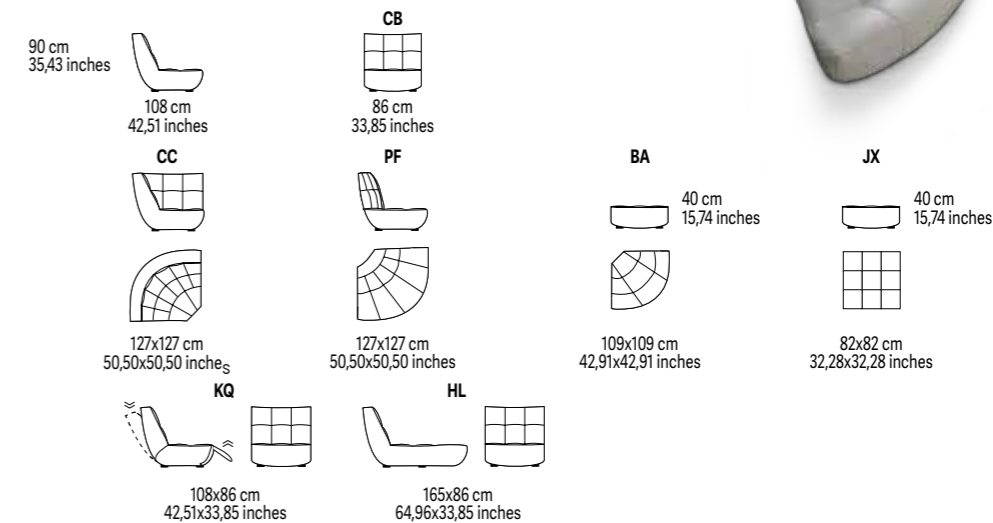

1722 FESTIVAL

RIVESTIMENTO: pelle, tessuto o microfibra; non sfoderabile
FUSTO: pannelli di fibra di legno e multistrato classe E1, assemblato con listelli in abete e/o faggio massello; le parti della struttura portante sono imbullonate
SOSPENSIONI SCHIENALE: cinghie elastiche
SOSPENSIONI SEDUTA: cinghie elastiche
IMBOTTITURA SCHIENALE: poliuretano espanso
IMBOTTITURA SEDUTA: poliuretano espanso
PIEDINO: piedino nero antiscivolo in plastica h. 3,5 cm
INFORMAZIONI AGGIUNTIVE: bordino e poggiatesta realizzabili in contrasto o tono su tono; relax elettrico in opzione

COVERING: leather, microfibre and fabric; not removable cover
FRAME CONSTRUCTION: hardwood load bearing rails, high density particle board, glued, screwed and stapled
BACK SUSPENSIONS: webbings (elastic belts)
SEAT SUSPENSIONS: webbings (elastic belts)
SEAT INTERIORS: polyurethane foam
BACK CUSHIONS: polyurethane foam
FEET: black non-slip plastic feet h. 3,5 cm
MORE INFORMATION: border and lumbar support available in contrast or tone on tone; available also with electric relax

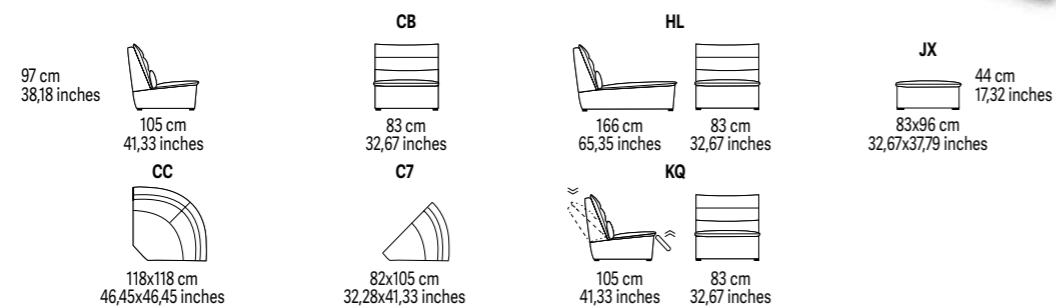

2220 GOLDEN

RIVESTIMENTO: pelle o tessuto; non sfoderabile
FUSTO: pannelli di fibra di legno e multistrato classe E1, assemblato con listelli in abete e/o faggio massello; le parti della struttura portante sono imbullonate
IMBOTTITURA SCHIENALE: poliuretano espanso
IMBOTTITURA SEDUTA: poliuretano espanso
SOSPENSIONI SCHIENALE: cinghie elastiche
SOSPENSIONI SEDUTA: cinghie elastiche
PIEDINO: piedini in metallo cromato canna di fucile h. 16 cm
SOTTO DIVANO: copertura parapolvere
INFORMAZIONI AGGIUNTIVE: poggiatesta regolabile

COVERING: leather and fabric; not removable cover
FRAME CONSTRUCTION: hardwood load bearing rails, high density particle board, glued, screwed and stapled
BACK CUSHIONS: polyurethane foam
SEAT INTERIORS: polyurethane foam
BACK SUSPENSIONS: webbings (elastic belts)
SEAT SUSPENSIONS: webbings (elastic belts)
FEET: dark grey chromed metal finishing h. 16 cm
UNDER BOTTOM: Dust cover
MORE INFORMATIONS: adjustable headrests

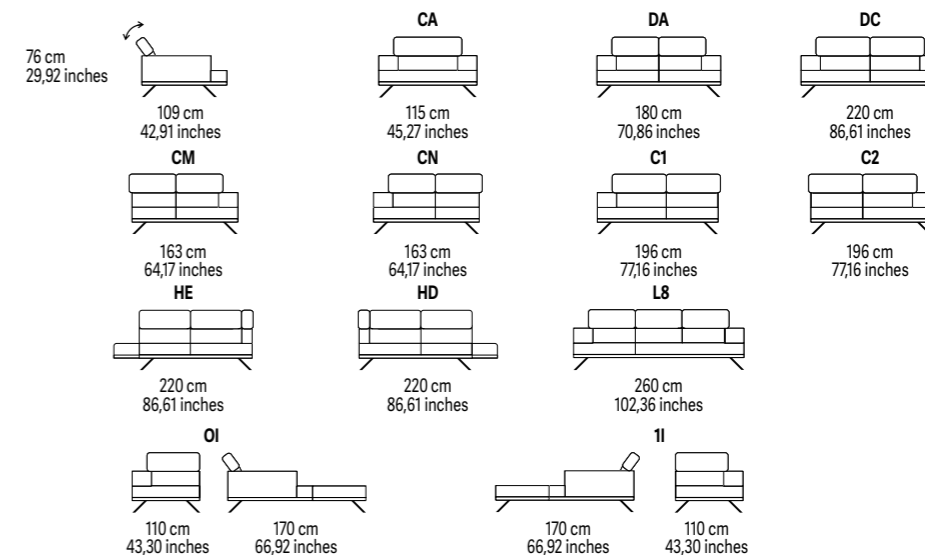

3780/3781
TERIN

RIVESTIMENTO: pelle, tessuto e microfibra, non sfoderabile
FUSTO: fusto realizzato in pannelli di truciolare e multistrato classe E1; assemblato con listelli in abete e/o faggio massello. Le parti della struttura portante sono imbullonate
SOSPENSIONI SEDUTA: Cinghie elastiche
SOSPENSIONI SCHIENALE: pannello in legno
IMBOTTITURA SEDUTA: poliuretano espanso + strato di resinato
IMBOTTITURA SCHIENALE: poliuretano espanso + Memory
PIEDINO: sostegno in plastica H4cm
ALTRE INFORMAZIONI:
 3781 Schienale scorrevole - versione elettrica
 3780 Schienale scorrevole - versione manuale

COVERING: leather and fabric; not removable cover
FRAME CONSTRUCTION: hardwood load bearing rails, high density particle board, glued, screwed and stapled
BACK CUSHIONS: polyurethane foam, Memory
SEAT INTERIORS: polyurethane foam, resin material
BACK SUSPENSIONS: wooden panel
SEAT SUSPENSIONS: webbings (elastic belts)
SEAT: plastic feet H 4cm
OTHER INFORMATION:
 3781 sliding backrest - electric version
 3780 sliding backrest - manual version

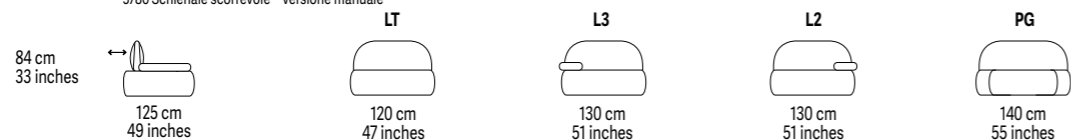

4001
LONG ISLAND

RIVESTIMENTO: pelle, tessuto, microfibra. Non sfoderabile
FUSTO: fusto realizzato in pannelli di truciolare e multistrato classe E1; assemblato con listelli in abete e/o faggio massello. Le parti della struttura portante sono imbullonate
SOSPENSIONI SEDUTA: cinghie elastiche
SOSPENSIONI SCHIENALE: assenti
IMBOTTITURA SEDUTA: poliuretano espanso
IMBOTTITURA SCHIENALE: fibra di poliestere
IMBOTTITURA BRACCIOLO: poliuretano espanso
PIEDINO: h14, metallo cromato, canna di fucile, marrone scuro
ALTRE INFORMAZIONI:
 - Cuscino GT: schienale optional elementi PH-HD-HE-11-13-P0-PZ
 - Vassoio 47x97 cm AR: modelli 4002 elem. MU-NE-CE-CF-I4-I5
 - Vassoio 97x97 cm 2G: modelli 4002 elem. OQ-OS-BI-BN
 - HD-HE-PH-11-13: tre cuscini schienale 50x50 cm compresi
 - PZ-P0: due cuscini schienale 50x50 cm e uno 40x40 cm compresi
 - Gli schienali da abbinare alle panche DG-DT sono optional e devono essere ordinati utilizzando il codice QY
 - Elementi sempre rifiniti lateralmente, anche se pelle

COVERING: leather, fabric and microfibre. Not removable cover
FRAME CONSTRUCTION: hardwood load bearing rails, high density particle board, glued, screwed and stapled
BACK CUSHIONS: polyester fiber
SEAT INTERIORS: polyurethane foam
SEAT SUSPENSIONS: webbings (elastic belts)
FEET: h 14cm - dark grey, brown, chromed metal finishing
OTHER INFORMATION:
 - Cushion GT: optional backrest elements PH-HD-HE-11-13-P0-PZ
 - Top 47x97 cm AR: models 4002 elem. MU-NE-CE-CF-I4-I5
 - Top 97x97 cm 2G: models 4002 elem. OQ-OS-BI-BN
 - HD-HE-PH-11-13: 3 backrest cushions included 50x50 cm
 - PZ-P0: 2 backrest cushions included 50x50 cm and 1 cushion 40x40 cm included
 - Backrests to match with elem. DG and DT are optional and have to be ordered with code QY
 - Elements are always finished laterally, even if in leather

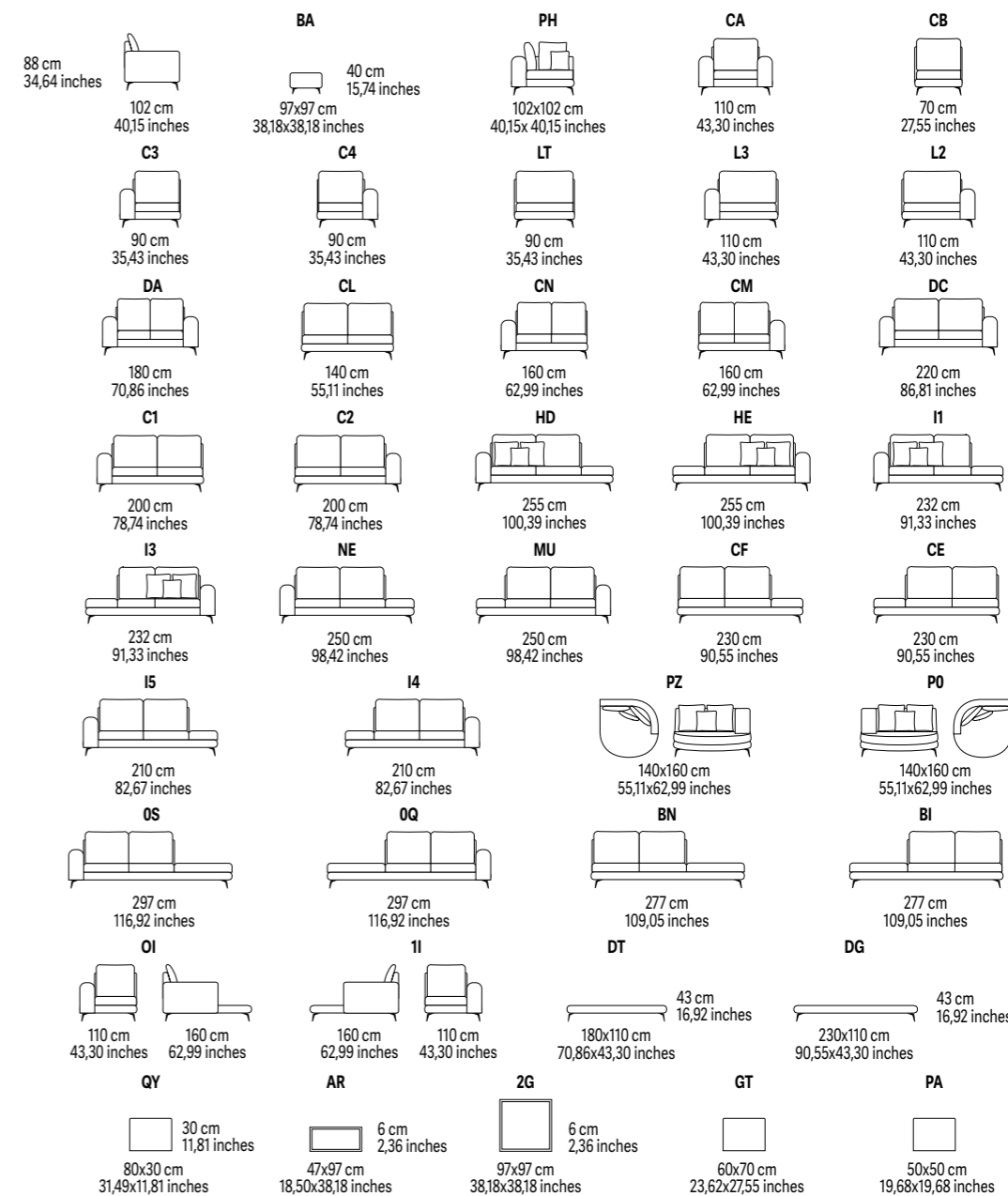

Le dimensioni sono indicative e possono subire modifiche / All dimensions are approximate and for guidance only
 Le cuciture nelle versioni in pelle possono variare rispetto alle versioni in tessuto / Stitchings in leather versions may vary compared to fabric ones

4002 LONG ISLAND

RIVESTIMENTO: pelle, tessuto, microfibra. Non sfoderabile
FUSTO: fusto realizzato in pannelli di truciolare e multistrato classe E1; assemblato con listelli in abete e/o faggio massello. Le parti della struttura portante sono imbullonate
SOSPENSIONI SEDUTA: cinghie elastiche
SOSPENSIONI SCHIENALE: assenti
IMBOTTITURA SEDUTA: poliuretano espanso
IMBOTTITURA SCHIENALE: fibra di poliestere
IMBOTTITURA BRACCIOLO: poliuretano espanso
PIEDINO: h14, metallo cromato, canna di fucile, marrone scuro
ALTRE INFORMAZIONI:
 - Cuscino GT: schienale optional elementi PH-HD-HE-11-13-P0-PZ
 - Vassoio 47x97 cm AR: modelli 4002 elem. MU-NE-CE-CF-I4-I5
 - Vassoio 97x97 cm 2G: modelli 4002 elem. OQ-OS-BI-BN
 - HD-HE-PH-11-13: tre cuscini schienale 50x50 cm compresi
 - PZ-P0: due cuscini schienale 50x50 cm e uno 40x40 cm compresi
 - Gli schienali da abbinare alle panche DG-DT sono optional e devono essere ordinati utilizzando il codice QY
 - Elementi sempre rifiniti lateralmente, anche se pelle

COVERING: leather, fabric and microfibre. Not removable cover
FRAME CONSTRUCTION: hardwood load bearing rails, high density particle board, glued, screwed and stapled
BACK CUSHIONS: polyurethane foam
SEAT INTERIORS: polyurethane foam
SEAT SUSPENSIONS: webbings (elastic belts)
FEET: h 14cm - dark grey, brown, chromed metal finishing
OTHER INFORMATION:
 - Cushion GT: optional backrest elements PH-HD-HE-11-13-P0-PZ
 - Top 47x97 cm AR: models 4002 elem. MU-NE-CE-CF-I4-I5
 - Top 97x97 cm 2G: models 4002 elem. OQ-OS-BI-BN
 - HD-HE-PH-11-13: 3 backrest cushions included 50x50 cm
 - PZ-P0: 2 backrest cushions included 50x50 cm and 1 cushion 40x40 cm included
 - Backrests to match with elem. DG and DT are optional and have to be ordered with code QY
 - Elements are always finished laterally, even if in leather

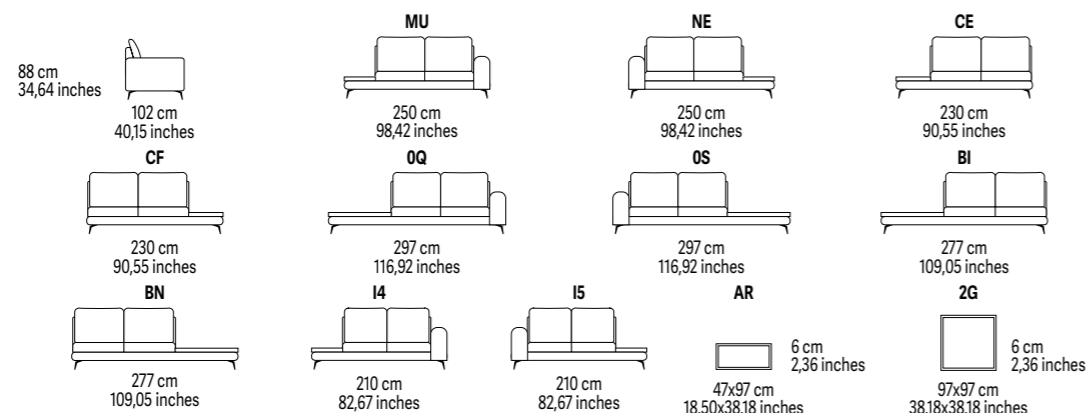

385E WONKA

RIVESTIMENTO: pelle, tessuto e microfibra, non sfoderabile
FUSTO: fusto realizzato in pannelli di truciolare e multistrato classe E1; assemblato con listelli in abete e/o faggio massello. Le parti della struttura portante sono imbullonate
SOSPENSIONI SEDUTA: cinghie elastiche
SOSPENSIONI SCHIENALE: cinghie elastiche
IMBOTTITURA SEDUTA: poliuretano espanso
IMBOTTITURA SCHIENALE: poliuretano espanso
PIEDINO: sostegno in plastica H6cm
OPZIONI: relax elettrico con doppio motore in opzione, poggiatesta reclinabili

COVERING: leather and fabric. Not removable
FRAME CONSTRUCTION: hardwood load bearing rails, high density particle board, glued, screwed and stapled
BACK CUSHIONS: polyurethane foam
SEAT INTERIORS: polyurethane foam
BACK SUSPENSIONS: webbings (elastic belts)
SEAT SUSPENSIONS: webbings (elastic belts)
SEAT: plastic feet H 6cm
OTHER INFORMATION:
 model with electric relax double motors

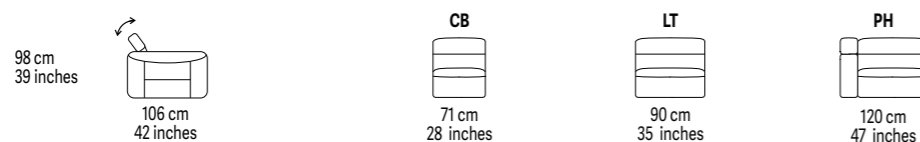

ELEMENTI CON RELAX ELETTRICO DOPPIO MOTORE ELEMENTS WITH ELECTRIC RELAX DOUBLE MOTORS



386E OYSTER

RIVESTIMENTO: pelle, tessuto e microfibra, non sfoderabile
FUSTO: fusto realizzato in pannelli di truciolare e multistrato classe E1; assemblato con listelli in abete e/o faggio massello. Le parti della struttura portante sono imbullonate
SOSPENSIONI SEDUTA: cinghie elastiche
SOSPENSIONI SCHIENALE: cinghie elastiche
IMBOTTITURA SEDUTA: poliuretano espanso
IMBOTTITURA SCHIENALE: poliuretano espanso
PIEDINO: piedino in metallo nero
OPZIONI: relax elettrico doppio motore, poggiatesta reclinabili
 386E: con presa elettrica
 386B: batteria integrata

COVERING: leather and fabric. Not removable
FRAME CONSTRUCTION: hardwood load bearing rails, high density particle board, glued, screwed and stapled
BACK CUSHIONS: polyurethane foam
SEAT INTERIORS: polyurethane foam
BACK SUSPENSIONS: webbings (elastic belts)
SEAT SUSPENSIONS: webbings (elastic belts)
ARM INTERIORS: polyurethane foam
FEET: plastic feet H6 cm
UNDER BOTTOM: dust cover
OTHER INFORMATION: adjustable headrests
 386E: wall plug
 386B: integrated battery

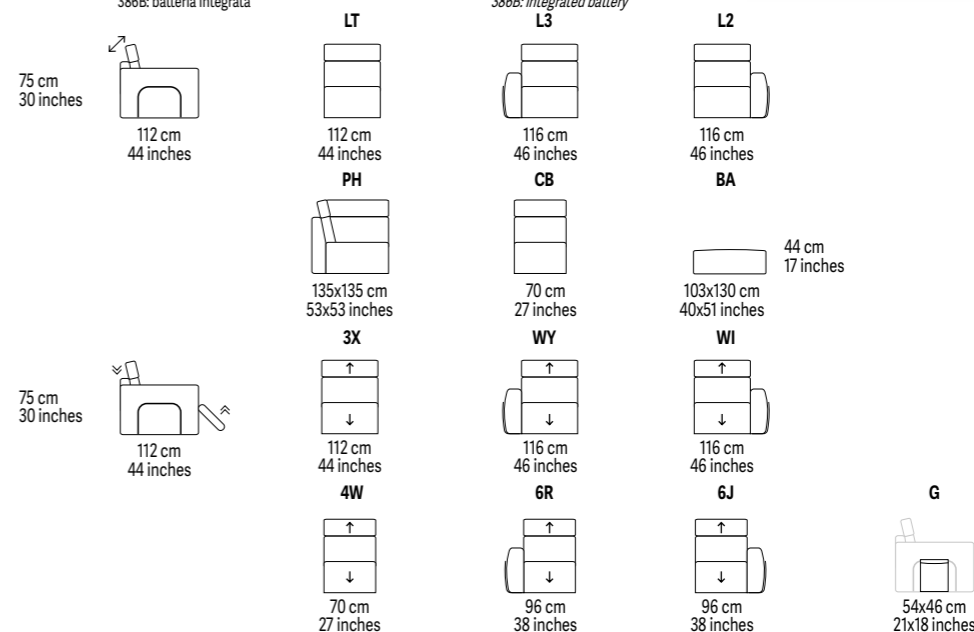

3051 SHIBUYA

RIVESTIMENTO: pelle, tessuto e microfibra, non sfoderabile
FUSTO: Fusto realizzato in pannelli di truciolare e multistrato classe E1; assemblato con listelli in abete e/o faggio massello. Le parti della struttura portante sono imbullonate
IMBOTTITURA SEDUTA: poliuretano espanso e fibra di poliestere
IMBOTTITURA SCHIENALE: poliuretano espanso e fibra di poliestere
PIEDINO: piedino in plastica nero H 6cm

COVERING: leather and fabric. Not removable
FRAME CONSTRUCTION: hardwood load bearing rails, high density particle board, glued, screwed and stapled
BACK CUSHIONS: polyurethane foam and polyester fiber layer
SEAT INTERIORS: polyurethane foam and polyester fiber layer
ARM INTERIORS: polyurethane foam and polyester fiber layer
SUSPENSIONS: no suspensions
FEET: plastic feet H3 cm
UNDER BOTTOM: dust cover



2327
SUZUKA

Elementi non componibili.
Pouf, divano 2 e 3 posti, chaise longue e panchetta. Free standing
Not modular elements. Pouf, 2 - 3 seater sofa, chaise longue, bench free standing

RIVESTIMENTO: pelle, tessuto o microfibra, non sfoderabile
FUSTO: pannelli di fibra di legno e multistrato classe E1, assemblato con listelli in abete massello e/o faggio massello. Le parti della struttura portante sono imbullonate
SOSPENSIONI SEDUTA: cinghie elastiche
SOSPENSIONI SCHIENALE: cinghie elastiche
IMBOTTITURA SEDUTA: poliuretano espanso
IMBOTTITURA SCHIENALE: poliuretano espanso
PIEDINO: metallico h. 18 cromato lucido e canna di fucile
ALTRE INFORMAZIONI: cricchietto schienale avanza e arretra

COVERING: leather and fabric; not removable cover
FRAME CONSTRUCTION: hardwood load bearing rails, high density particle board, glued, screwed and stapled - iron frame in the armrest
BACK CUSHIONS: polyurethane foam
SEAT INTERIORS: polyurethane foam
BACK SUSPENSIONS: webbings (elastic belts)
SEAT SUSPENSIONS: webbings (elastic belts)
FEET: chromes metal feet gun-barrel grey finish h. 18 cm
Other information: sliding backrest

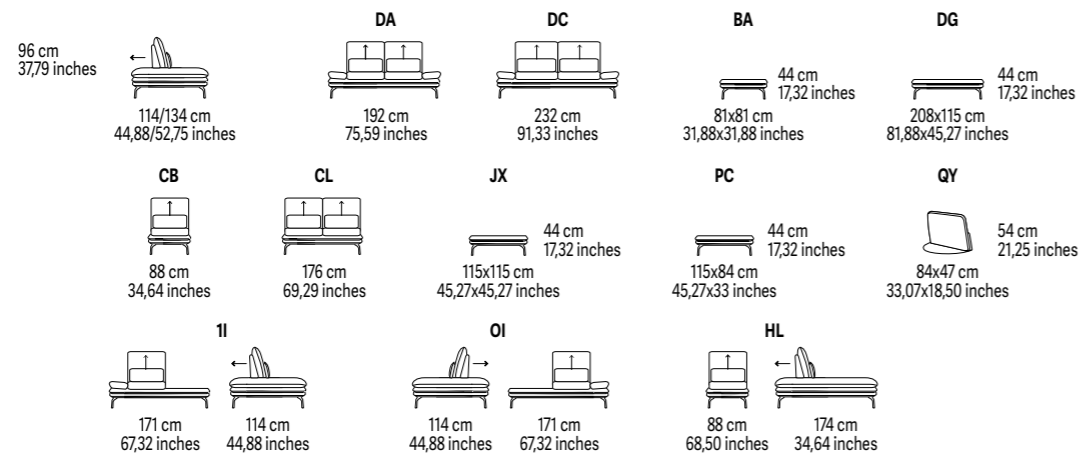

2328
SUZUKA

Elementi componibili. Non free standing.
Not free standing elements

RIVESTIMENTO: pelle, tessuto o microfibra, non sfoderabile
FUSTO: pannelli di fibra di legno e multistrato classe E1, assemblato con listelli in abete massello e/o faggio massello. Le parti della struttura portante sono imbullonate
SOSPENSIONI SEDUTA: cinghie elastiche
SOSPENSIONI SCHIENALE: cinghie elastiche
IMBOTTITURA SEDUTA: poliuretano espanso
IMBOTTITURA SCHIENALE: poliuretano espanso
PIEDINO: metallico h. 18 cromato lucido e canna di fucile
ALTRE INFORMAZIONI: cricchietto schienale avanza e arretra

COVERING: leather and fabric; not removable cover
FRAME CONSTRUCTION: hardwood load bearing rails, high density particle board, glued, screwed and stapled - iron frame in the armrest
BACK CUSHIONS: polyurethane foam
SEAT INTERIORS: polyurethane foam
BACK SUSPENSIONS: webbings (elastic belts)
SEAT SUSPENSIONS: webbings (elastic belts)
FEET: chromes metal feet gun-barrel grey finish h. 18 cm
Other information: sliding backrest

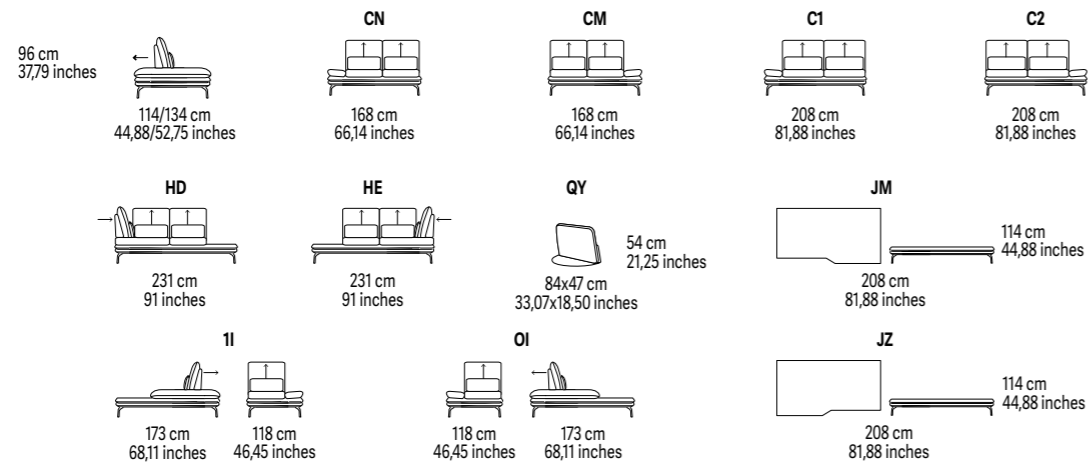

P353
JULIA
pag. / page 110

RIVESTIMENTO: pelle, microfibra o tessuto; non sfoderabile
FUSTO: pannelli di fibra di legno e multistrato classe E1, assemblato con listelli in abete e/o faggio massello; le parti della struttura portante sono imbullonate
IMBOTTITURA SCHIENALE: piuma
IMBOTTITURA SEDUTA: poliuretano espanso + memory
SOSPENSIONI SCHIENALE: tamponamento in faesite
SOSPENSIONI SEDUTA: cinghie elastiche
PIEDINO: piedino nero in plastica 3 mm

COVERING: leather, microfibre and fabric; not removable cover
FRAME CONSTRUCTION: hardwood load bearing rails, high density particle board, glued, screwed and stapled
BACK CUSHIONS: feather
SEAT INTERIORS: polyurethane foam + memory
BACK SUSPENSIONS: support panel in hardboard
SEAT SUSPENSIONS: webbings (elastic belts)
FEET: black plastic feet 3 mm

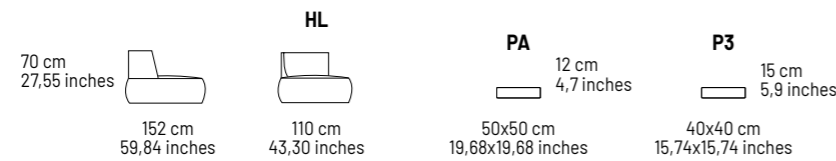

P140
BRIGITTE
pag. / page 111

RIVESTIMENTO: pelle o tessuto; non sfoderabile
FUSTO: pannelli di fibra di legno e multistrato classe E1, assemblato con listelli in abete e/o faggio massello; le parti della struttura portante sono imbullonate
IMBOTTITURA SCHIENALE: poliuretano espanso
IMBOTTITURA SEDUTA: poliuretano espanso
SOSPENSIONI SEDUTA: cinghie elastiche
SOTTO DIVANO: copertura parapolvere
PIEDINI: piedini in plastica colore nero h. 2 cm

COVERING: leather and fabric; not removable cover
FRAME CONSTRUCTION: hardwood load bearing rails, high density particle board, glued, screwed and stapled
BACK CUSHIONS: polyurethane foam
SEAT INTERIORS: polyurethane foam
SEAT SUSPENSIONS: webbings (elastic belts)
UNDER BOTTOM: dust cover
FEET: black plastic feet h. 2 cm

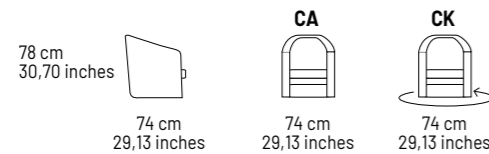

P321
KRIS SWIVEL

RIVESTIMENTO: pelle o microfibra; non sfoderabile
FUSTO: pannelli di fibra di legno e multistrato classe E1, assemblato con listelli in abete massello e/o faggio massello; le parti della struttura portante sono imbullonate
SOSPENSIONI SEDUTA: cinghie elastiche
SOSPENSIONI SCHIENALE: cinghie elastiche
IMBOTTITURA SEDUTA: poliuretano espanso
IMBOTTITURA SCHIENALE: poliuretano espanso
PIEDINO: base piatta girevole in legno laccato nero

COVERING: leather and fabric; not removable cover
FRAME CONSTRUCTION: hardwood load bearing rails, high density particle board, glued, screwed and stapled
SEAT SUSPENSIONS: webbings (elastic belts)
BACK SUSPENSIONS: webbings (elastic belts)
SEAT INTERIORS: polyurethane foam
BACK CUSHIONS: polyurethane foam
FEET: swivel flat base in black lacquered wood

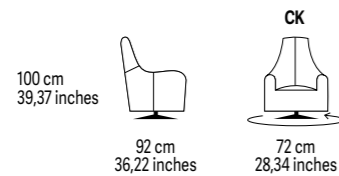

P322
HANSEL
pag. / page 113

RIVESTIMENTO: pelle o microfibra; non sfoderabile
FUSTO: pannelli di fibra di legno e multistrato classe E1, assemblato con listelli in abete massello e/o faggio massello; le parti della struttura portante sono imbullonate
SOSPENSIONI SEDUTA: cinghie elastiche
SOSPENSIONI SCHIENALE: tamponamento in faesite
IMBOTTITURA SEDUTA: poliuretano espanso
IMBOTTITURA SCHIENALE: poliuretano espanso
PIEDINO: versione girevole con basamento piatto in legno colore nero con dondolo

COVERING: leather and fabric; not removable cover
FRAME CONSTRUCTION: hardwood load bearing rails, high density particle board, glued, screwed and stapled
SEAT SUSPENSIONS: webbings (elastic belts)
BACK SUSPENSIONS: support panel in hardboard
SEAT INTERIORS: polyurethane foam
BACK CUSHIONS: polyurethane foam
FEET: swivel flat base in black wood; rocking base

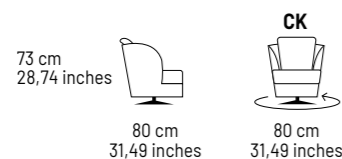

P344
JOLLA
pag. / page 114

RIVESTIMENTO: pelle o microfibra; non sfoderabile
FUSTO: misto legno massello, rinforzato con pannelli di particelle; struttura in metallo
SOSPENSIONI SEDUTA: cinghie elastiche
SOSPENSIONI SCHIENALE: cinghie elastiche
IMBOTTITURA SEDUTA: poliuretano espanso
IMBOTTITURA SCHIENALE: poliuretano espanso
PIEDINO: base girevole con basamento piatto in metallo

COVERING: leather and fabric; not removable cover
FRAME CONSTRUCTION: mixed solid wood, reinforced with particle board; metal structure
SEAT SUSPENSIONS: webbings (elastic belts)
BACK SUSPENSIONS: webbings (elastic belts)
SEAT INTERIORS: polyurethane foam
BACK CUSHIONS: polyurethane foam
FEET: swivel flat base in metal

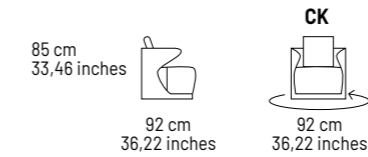

P189
PLUTONE
pag. / page 115

RIVESTIMENTO: pelle o microfibra; non sfoderabile
FUSTO: pannelli di fibra di legno e multistrato classe E1, assemblato con listelli in abete e/o faggio massello; le parti della struttura portante sono imbullonate
IMBOTTITURA SCHIENALE: poliuretano espanso
IMBOTTITURA SEDUTA: poliuretano espanso
SOSPENSIONI SCHIENALE: tamponamento in faesite
SOSPENSIONI SEDUTA: cinghie elastiche
PIEDINI: piedini neri in plastica h. 4 cm
SOTTO DIVANO: copertura parapolvere

COVERING: leather and microfibre; not removable cover
FRAME CONSTRUCTION: hardwood load bearing rails, high density particle board, glued, screwed and stapled
BACK CUSHIONS: polyurethane foam
SEAT INTERIORS: polyurethane foam
BACK SUSPENSIONS: support panel in hardboard
SEAT SUSPENSIONS: webbings (elastic belts)
FEET: black plastic feet h. 4 cm
UNDER BOTTOM: dust cover

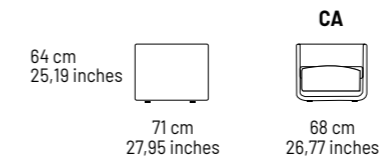

P332
ISOTTA IRON
pag. / page 116

RIVESTIMENTO: pelle o microfibra; non sfoderabile
FUSTO: pannelli di fibra di legno e multistrato classe E1, assemblato con listelli in abete massello e/o faggio massello; le parti della struttura portante sono imbullonate
SOSPENSIONI SEDUTA: cinghie elastiche
SOSPENSIONI SCHIENALE: tamponamento in faesite
IMBOTTITURA SEDUTA: poliuretano espanso
IMBOTTITURA SCHIENALE: poliuretano espanso
PIEDINO: base in metallo cromato h. 15 cm

COVERING: leather and fabric; not removable cover
FRAME CONSTRUCTION: hardwood load bearing rails, high density particle board, glued, screwed and stapled
SEAT SUSPENSIONS: webbings (elastic belts)
BACK SUSPENSIONS: support panel in hardboard
SEAT INTERIORS: polyurethane foam
BACK CUSHIONS: polyurethane foam
FEET: base in chromed metal h. 15 cm

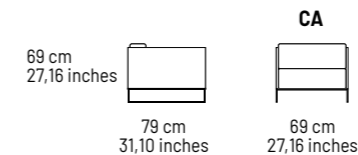

P318
EASTWAY

RIVESTIMENTO: pelle o microfibra; non sfoderabile
FUSTO: struttura in metallo
SOSPENSIONI SEDUTA: Tamponamento in faesite
SOSPENSIONI SCHIENALE: tamponamento in faesite
IMBOTTITURA SEDUTA: poliuretano espanso
IMBOTTITURA SCHIENALE: poliuretano espanso
PIEDINO: base in metallo laccato marrone h. 43/60 cm

COVERING: leather and fabric; not removable cover
FRAME CONSTRUCTION: metal frame
SEAT SUSPENSIONS: support panel in hardboard
BACK SUSPENSIONS: support panel in hardboard
SEAT INTERIORS: polyurethane foam
BACK CUSHIONS: polyurethane foam
FEET: base in brown lacquered metal h. 43/60 cm

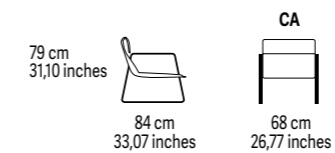

P343
AMY
 pag. / page 118

RIVESTIMENTO: pelle, tessuto o microfibra; non sfoderabile
FUSTO: pannelli di fibra di legno e multistrato classe E1, assemblato con listelli in abete massello e/o faggio massello; le parti della struttura portante sono imbullonate
SOSPENSIONI SEDUTA: cinghie elastiche
SOSPENSIONI SCHIENALE: pannello in faesite
IMBOTTITURA SEDUTA: poliuretano espanso
IMBOTTITURA SCHIENALE: poliuretano espanso
PIEDINO: base in legno
CARATTERISTICHE: poltrona girevole

COVERING: leather, microfibre and fabric; not removable cover
FRAME CONSTRUCTION: Hardwood load bearing rails, high density particle board, glued, screwed and stapled density particle board, glued, screwed and stapled
SEAT SUSPENSIONS: webbings (elastic belts)
BACK SUSPENSIONS: hardboard
SEAT INTERIORS: Premium high density high resiliency foam + memory + feathers
BACK CUSHIONS: premium high density high resiliency foam
FEET: wooden base
OTHER INFORMATIONS: swivel chair

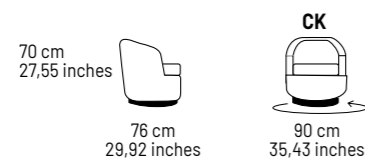

P35
TROPHEE

RIVESTIMENTO: pelle o microfibra; non sfoderabile
FUSTO: pannelli di fibra di legno e multistrato classe E1, assemblato con listelli in abete massello e/o faggio massello; le parti della struttura portante sono imbullonate
SOSPENSIONI SEDUTA: cinghie elastiche
SOSPENSIONI SCHIENALE: tamponamento in faesite
IMBOTTITURA SEDUTA: poliuretano espanso
IMBOTTITURA SCHIENALE: poliuretano espanso
PIEDINO: base girevole a 5 razze in metallo colore nero
CARATTERISTICHE: poltrona girevole

COVERING: Leather and microfibre; not removable cover
FRAME CONSTRUCTION: hardwood load bearing rails, high density particle board, glued, screwed and stapled
SEAT SUSPENSIONS: webbings (elastic belts)
BACK SUSPENSIONS: support panel in hardboard
SEAT INTERIORS: polyurethane foam
BACK CUSHIONS: polyurethane foam
FEET: swivel 5 stars base in black metal finishing
OTHER INFORMATIONS: swivel chair

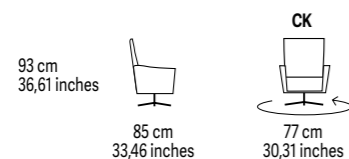

P164
JANE
 pag. / page 120

RIVESTIMENTO: RIVESTIMENTO: pelle, tessuto o microfibra; non sfoderabile
FUSTO: pannelli di fibra di legno e multistrato classe E1, assemblato con listelli in abete e/o faggio massello
SOSPENSIONI SEDUTA: cinghie elastiche
SOSPENSIONI SCHIENALE: cinghie elastiche
IMBOTTITURA SEDUTA: poliuretano espanso + piumino
IMBOTTITURA SCHIENALE: poliuretano espanso + piumino
PIEDINO: piedini in metallo 1 cm

COVERING: leather, microfibre and fabric; not removable cover
FRAME CONSTRUCTION: Hardwood load bearing rails, high density particle board, glued, screwed and stapled
SEAT SUSPENSIONS: webbings (elastic belts)
BACK SUSPENSIONS: webbings (elastic belts)
SEAT INTERIORS: premium high density high resiliency foam, encased in down
BACK CUSHIONS: premium high density high resiliency foam, encased in down
FEET: metal feet 1 cm

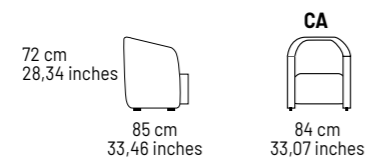

BRICK



TA61EC

BASKET



TA71EA

TA72EA

TA73EA

LOOP



LOOP EC

CROWD



2008 BA

FTA1 EC

FTA2 EC

TA61 EC

Tavolino rettangolare
Rectangular coffee table
L / W 90 cm - 35,43 inches
P / D 45 cm - 17,71 inches
H / H 35 cm - 13,77 inches

Tavolino rettangolare con struttura in metallo e top in legno o laccato opaco.

Rectangular coffee table with metal structure and top in wood or matt lacquered.

TA71 EA

Tavolino alto
High coffee table
L / W 40 cm - 15,74 inches
P / D 40 cm - 15,74 inches
H / H 43 cm - 16,92 inches

TA72 EA

Tavolino medio
Medium coffee table
L / W 50 cm - 19,68 inches
P / D 50 cm - 19,68 inches
H / H 33 cm - 12,99 inches

TA73 EA

Tavolino basso
Low coffee table
L / W 90 cm - 35,43 inches
P / D 90 cm - 35,43 inches
H / H 23 cm - 9,05 inches

Tavolino rotondo con struttura in metallo verniciato e top in legno.

Round coffee table with painted metal structure and top in wood or matt lacquered.

FINITURE STRUTTURA IN METALLO / METAL FINISHING STRUCTURE

- 01013** Laccato opaco bianco perla
Matt lacquered pearl white
- 08019** Laccato opaco marrone
Matt lacquered brown
- 09003** Laccato opaco bianco segnale
Matt lacquered white

FINITURE TOP / TOP FINISHES

- 01013** Laccato opaco bianco perla
Matt lacquered pearl white
- 08019** Laccato opaco marrone
Matt lacquered brown
- 09003** Laccato opaco bianco segnale
Matt lacquered white
- NOCES** Noce scuro
Dark walnut

FINITURE STRUTTURA IN METALLO / METAL FINISHING STRUCTURE

- 01013** Laccato opaco bianco perla
Matt lacquered pearl white
- 08019** Laccato opaco marrone
Matt lacquered brown
- 09003** Laccato opaco bianco segnale
Matt lacquered white

FINITURE TOP / TOP FINISHES

- 01013** Laccato opaco bianco perla
Matt lacquered pearl white
- 08019** Laccato opaco marrone
Matt lacquered brown
- 09003** Laccato opaco bianco segnale
Matt lacquered white
- NOCES** Noce scuro
Dark walnut

LOOP EC

Tavolino
Coffee table
L / W 120 cm - 47,24 inches
P / D 75 cm - 29,52 inches
H / H 32/25 cm - 12,59/9,84 inches

Tavolino rettangolare doppio in metallo verniciato.

Coffee table in painted metal.

FINITURE IN METALLO / METAL FINISHING

- 01013** Laccato opaco bianco perla
Matt lacquered pearl white
- 08019** Laccato opaco marrone
Matt lacquered brown
- 09003** Laccato opaco bianco segnale
Matt lacquered white

FTA2 EC

Tavolino piccolo
Small coffee table
L / W 50 cm - 19,68 inches
P / D 50 cm - 19,68 inches
H / H 40 cm - 15,74 inches

FTA1 EC

Tavolino grande
Big coffee table
L / W 95 cm - 37,40 inches
P / D 65 cm - 25,59 inches
H / H 35 cm - 13,77 inches

2008 BA

Pouf
Ottoman
L / W 80 cm - 31,49 inches
P / D 65 cm - 25,59 inches
H / H 30 cm - 11,81 inches

Tavolino con struttura in metallo verniciato e top in legno, possibilità di aggiunta pouf.

Coffee table with metal structure and top in wood or matt lacquered, ottoman available.

FINITURE STRUTTURA IN METALLO / METAL FINISHING STRUCTURE

- 01013** Laccato opaco bianco perla
Matt lacquered pearl white
- 08019** Laccato opaco marrone
Matt lacquered brown
- 09003** Laccato opaco bianco segnale
Matt lacquered white

FINITURE TOP / TOP FINISHES

- 01013** Laccato opaco bianco perla
Matt lacquered pearl white
- 08019** Laccato opaco marrone
Matt lacquered brown
- 09003** Laccato opaco bianco segnale
Matt lacquered white
- NOCES** Noce scuro
Dark walnut

AROMA



TARO EC

TARO EC

Tavolino multipiano
Multi coffee table
L / W 110 cm - 43,30 inches
P / D 77 cm - 30,31 inches
H / H 38/28/18 cm - 14,96/11,02/7,08 inches

Tavolino multipiano con struttura in metallo verniciato e top in legno o laccato opaco.

Coffee table multi-storey metal structure, top in wood or matt lacquered.

FINITURE STRUTTURA IN METALLO / METAL FINISHING STRUCTURE

01013 Laccato opaco bianco perla
Matt lacquered pearl white

08019 Laccato opaco marrone
Matt lacquered brown

09003 Laccato opaco bianco segnale
Matt lacquered white

FINITURE TOP / TOP FINISHES

01013 Laccato opaco bianco perla
Matt lacquered pearl white

08019 Laccato opaco marrone
Matt lacquered brown

09003 Laccato opaco bianco segnale
Matt lacquered white

NOCES Noce scuro
Dark walnut

NOODLES



TA11 EA

TA12 EA

TA12 EA

Tavolino basso
Low coffee table
L / W 50 cm - 19,68 inches
P / D 50 cm - 19,68 inches
H / H 35 cm - 13,77 inches

Tavolino rotondo con struttura in metallo laccato e top in legno o finitura laccato opaco.

Round coffee table with painted metal base and top in wood or matt lacquered.

TA11 EA

Tavolino alto
High coffee table
L / W 50 cm - 19,68 inches
P / D 50 cm - 19,68 inches
H / H 50 cm - 19,68 inches

FINITURE STRUTTURA IN METALLO / METAL FINISHING STRUCTURE

01013 Laccato opaco bianco perla
Matt lacquered pearl white

08019 Laccato opaco marrone
Matt lacquered brown

09003 Laccato opaco bianco segnale
Matt lacquered white

FINITURE TOP / TOP FINISHES

01013 Laccato opaco bianco perla
Matt lacquered pearl white

08019 Laccato opaco marrone
Matt lacquered brown

09003 Laccato opaco bianco segnale
Matt lacquered white

NOCES Noce scuro
Dark walnut

PAUL



TM02 EB



TA21 EC

TM02 EB

Tavolino quadrato
Square coffee table
L / W 130 cm - 51,18 inches
P / D 130 cm - 51,18 inches
H / H 25 cm - 9,84 inches
top laccato opaco o legno
wooden or matt lacquered top

Tavolino quadrato o rettangolare con struttura in metallo verniciato e top in legno o finitura laccato opaco.
Square or rectangular coffee table with painted metal base and top in wood, matt lacquered.

FINITURE STRUTTURA IN METALLO / METAL FINISHING STRUCTURE

01013 Laccato opaco bianco perla
Matt lacquered pearl white

08019 Laccato opaco marrone
Matt lacquered brown

09003 Laccato opaco bianco segnale
Matt lacquered white

FINITURE TOP / TOP FINISHES

01013 Laccato opaco bianco perla
Matt lacquered pearl white

08019 Laccato opaco marrone
Matt lacquered brown

09003 Laccato opaco bianco segnale
Matt lacquered white

NOCES Noce scuro
Dark walnut

OTTO



OTTO EC

OTTO EC

Tavolino ovale con struttura e top in finitura impiallacciato rovere termo trattato.
Oval coffee table with structure and top in heat-treated oak finishing
 L / W 50 cm - 19,68 inches
 P / D 45 cm - 17,71 inches
 H / H 49 cm - 19,29 inches

FINITURE STRUTTURA E TOP / STRUCTURE ANF TOP FINISHING

ROTER
 Rovere termo trattato
 Heat-treated oak

SOLANGE



TA42 ED

2007 BA

TA41 ED

TA42 ED

Tavolino piccolo
Small coffee table
 L / W 45 cm - 17,71 inches
 P / D 45 cm - 17,71 inches
 H / H 47 cm - 18 inches

TA41 ED

Tavolino grande
Big coffee table
 L / W 120 cm - 47,24 inches
 P / D 120 cm - 47,24 inches
 H / H 37 cm - 14 inches

FINITURE STRUTTURA IN METALLO / METAL FINISHING STRUCTURE

01013
 Laccato opaco bianco perla
 Matt lacquered pearl white

09003
 Laccato opaco bianco segnale
 Matt lacquered white

FINITURE TOP / TOP FINISHES

01013
 Laccato opaco bianco perla
 Matt lacquered pearl white

09003
 Laccato opaco bianco segnale
 Matt lacquered white

2007 BA

Pouf
Ottoman
 L / W 120 cm - 47,24 inches
 P / D 120 cm - 47,24 inches
 H / H 30 cm - 11,81 inches

08019
 Laccato opaco marrone
 Matt lacquered brown

08019
 Laccato opaco marrone
 Matt lacquered brown

NOCES
 Noce scuro
 Dark walnut

CIRCO



CT23

CT24

CT22

CT23

Tavolino rotondo alto
Rond high coffee table
 L / W 35 cm - 13,77 inches
 P / D 35 cm - 13,77 inches
 H / H 45 cm - 17,71 inches

CT24

Tavolino rotondo medio
Rond medium coffee table
 L / W 60 cm - 23,62 inches
 P / D 60 cm - 23,62 inches
 H / H 35 cm - 13,77 inches

FINITURE STRUTTURA IN METALLO / METAL FINISHING STRUCTURE

BM002
 Laccato piombo
 Lacquered dark grey

BM004
 Laccato bronzo
 Lacquered bronze

FINITURE TOP / TOP FINISHES

SPBRO
 Specchio bronzato
 Bronzed glass

SPFUM
 Specchio fumè
 Smoked mirror

CT22

Tavolino rotondo basso
Rond low coffee table
 L / W 100 cm - 37,37 inches
 P / D 100 cm - 37,37 inches
 H / H 28 cm - 11,02 inches

Tavolini rotondi con struttura in metallo verniciato e top in finitura specchio.

Rond coffee tables with metal structure and top with glass finishing.

08019
 Laccato opaco marrone
 Matt lacquered brown

SPFUM
 Specchio fumè
 Smoked mirror

TRAMPOLINO



TRA1

TRA1

Tavolino rettangolare
Rectangular table
 L / W 90 cm - 35,43 inches
 P / D 50 cm - 19,63 inches
 H / H 50 cm - 19,63 inches

Struttura in metallo verniciato e top in finitura impiallacciato rovere termo trattato.
Rectangular coffee table with painted metal structure and top in heat-treated oak veneer finishing.

FINITURE STRUTTURA IN METALLO / METAL FINISHING STRUCTURE

BM002
 Laccato piombo
 Lacquered dark grey

BM004
 Laccato bronzo
 Lacquered bronze

FINITURE TOP / TOP FINISHES

ROTER
 Rovere termo trattato
 Heat-treated oak

COMPOSTO



CMP1 EB

COMPOSTO DUE



CMP2 EC

CMP1 EB

Tavolino quadrato
Square coffe table
L / W 45 cm - 17,71 inches
P / D 45 cm - 17,71 inches
H / H 49 cm - 19,29 inches

Tavolino quadrato con struttura e top in finitura impiallacciato rovere termo trattato.

Square coffe table with structure and top in heat-treated oak finishing.

FINITURE STRUTTURA E TOP / STRUCTURE ANF TOP FINISHING

ROTER
Rovere termo trattato
Heat-treated oak

CMP2 EC

Tavolino rettangolare
Rectangular coffe table
L / W 43 cm - 16,92 inches
P / D 34 cm - 13,38 inches
H / H 53 cm - 20,36 inches

Tavolino rettangolare con struttura e top in metallo laccato.

Rectangular coffe table with structure and top in lacquered metal finishing.

FINITURE / FINISHING

BM002
Laccato piombo
Lacquered dark grey

BM004
Laccato bronzo
Lacquered bronze

O8019
Laccato opaco marrone
Matt lacquered brown

GABBIA



GA17

GA18

GA19

GA17

Tavolino basso
Low coffee table
L / W 102 cm - 40,15 inches
P / D 102 cm - 40,15 inches
H / H 35 cm - 13,77 inches

GA18

Tavolino alto
High coffee table
L / W 42 cm - 16,53 inches
P / D 42 cm - 16,53 inches
H / H 45 cm - 17,71 inches

FINITURE STRUTTURA IN METALLO / METAL FINISHING STRUCTURE

BM002
Laccato piombo
Lacquered dark grey

BM004
Laccato bronzo
Lacquered bronze

FINITURE TOP / TOP FINISHES

VEBRO
Vetro bronzato
Bronzed glass

GA19

Tavolino medio
Medium coffee table
L / W 72 cm - 28,34 inches
P / D 72 cm - 28,34 inches
H / H 40 cm - 15,74 inches

Tavolino rotondo, con struttura in metallo laccato e top in vetro bronzato o fumè.
Coffee table with lacquered metal structure and smoked or bronzed glass.

O8019
Laccato opaco marrone
Matt lacquered brown

VEFUM
Vetro fumè
Smoked mirror

TRIANGOLO



TRLM

TRSL

TRLL

TRLM

Tavolino rotondo alto
Rond high coffee table
L / W 45 cm - 17,71 inches
P / D 45 cm - 17,71 inches
H / H 52 cm - 20,47 inches

TRSL

Tavolino rotondo medio
Rond medium coffee table
L / W 60 cm - 23,62 inches
P / D 60 cm - 23,62 inches
H / H 42 cm - 16,53 inches

FINITURE STRUTTURA IN METALLO / METAL FINISHING STRUCTURE

BM002
Laccato piombo
Lacquered dark grey

BM004
Laccato bronzo
Lacquered bronze

FINITURE TOP / TOP FINISHES

ROTER
Rovere termo trattato
Heat-treated oak

TRLL

Tavolino rotondo basso
Rond low coffee table
L / W 90 cm - 35,43 inches
P / D 90 cm - 35,43 inches
H / H 32 cm - 12,59 inches

Tavolino con struttura in metallo verniciato e top in rovere termo trattato marmo.

Coffee table with lacquered metal structure and top in heat treated oak or marble.

O8019
Laccato opaco marrone
Matt lacquered brown

MMEGU
Verde Guatemala cat. 1
Marble Verde Guatemala cat. 1

IBIS



IB50

Tavolino tondo alto
Rond high coffee table
 L / W 50 cm - 19,68 inches
 P / D 50 cm - 19,68 inches
 H / H 46 cm - 18,11 inches

IBQS

Tavolino quadrato
Square coffee table
 L / W 80 cm - 31,49 inches
 P / D 80 cm - 31,49 inches
 H / H 36 cm - 14,17 inches

Tavolino con struttura in metallo verniciato e top in vetro.
Coffee table with painted metal structure and glass top.

IB8R

Tavolino tondo basso
Rond low coffee table
 L / W 80 cm - 31,49 inches
 P / D 80 cm - 31,49 inches
 H / H 36 cm - 14,17 inches

IBRS

Tavolino rettangolare
Rectangular coffee table
 L / W 130 cm - 51,18 inches
 P / D 70 cm - 27,55 inches
 H / H 34 cm - 13,38 inches

FINITURE STRUTTURA IN METALLO / METAL FINISHING STRUCTURE

BM002
 Laccato piombo
Lacquered dark grey

08019
 Laccato opaco marrone
Matt lacquered brown

BM004
 Laccato bronzo
Lacquered bronze

FINITURE TOP / TOP FINISHES

VEBRO
 Vetro bronzato
Bronzed glass

VEFUM
 Vetro fumè
Smoked mirror

RING



R12S / R12P

Tavolino
Coffee table
 L / W 35 cm - 13,77 inches
 P / D 35 cm - 13,77 inches
 H / H 35 cm - 13,77 inches

R23S / R23P

Tavolino
Coffee table
 L / W 35 cm - 13,77 inches
 P / D 57 cm - 22,44 inches
 H / H 60 cm - 23,62 inches

R42S / R42P

Tavolino
Coffee table
 L / W 35 cm - 13,77 inches
 P / D 90 cm - 35,43 inches
 H / H 70 cm - 27,55 inches

R52S / R52P

Tavolino
Coffee table
 L / W 90 cm - 35,43 inches
 P / D 90 cm - 35,43 inches
 H / H 25 cm - 9,84 inches

R13S / R13P

Tavolino
Coffee table
 L / W 35 cm - 13,77 inches
 P / D 35 cm - 13,77 inches
 H / H 70 cm - 27,55 inches

R32S / R32P

Tavolino
Coffee table
 L / W 50 cm - 19,68 inches
 P / D 50 cm - 19,68 inches
 H / H 42 cm - 16,53 inches

R43S / R43P

Tavolino
Coffee table
 L / W 35 cm - 13,77 inches
 P / D 57 cm - 22,44 inches
 H / H 70 cm - 27,55 inches

FINITURE STRUTTURA IN METALLO / METAL FINISHING STRUCTURE

BM002
 Laccato piombo
Lacquered dark grey

08019
 Laccato opaco marrone
Matt lacquered brown

BM004
 Laccato bronzo
Lacquered bronze

FINITURE TOP / TOP FINISHES

SPBRO
 Specchio bronzato
Bronzed glass

SPFUM
 Specchio fumè
Smoked mirror

LAMBERT



L143
Tavolino
Coffee table
L / W 140 cm - 55 inches
P / D 70 cm - 28 inches
H / H 32 cm - 13 inches

L505
Tavolino
Coffee table
L / W 50 cm - 20 inches
P / D 50 cm - 20 inches
H / H 50 cm - 20 inches

L804
Tavolino
Coffee table
L / W 80 cm - 32 inches
P / D 80 cm - 32 inches
H / H 40 cm - 16 inches

L504
Tavolino
Coffee table
L / W 50 cm - 20 inches
P / D 50 cm - 20 inches
H / H 40 cm - 16 inches

FINITURE Colori disponibili come da campionario
FINISHING Please refer to the samples box of finishes

WONKA



RS2B
Tavolino
Coffee table
L / W 97 cm - 38 inches
P / D 97 cm - 38 inches
H / H 26 cm - 10 inches

RS2C
Tavolino
Coffee table
L / W 97 cm - 38 inches
P / D 47 cm - 18 inches
H / H 26 cm - 10 inches

FINITURE Colori disponibili come da campionario
FINISHING Please refer to the samples box of finishes

ARTIS



ARTE
Tavolino
Coffee table
L / W 100 cm - 40 inches
P / D 100 cm - 40 inches
H / H 25 cm - 10 inches

ARTG
Tavolino
Coffee table
L / W 35 cm - 14 inches
P / D 45 cm - 18 inches
H / H 51 cm - 20 inches

ARTF
Tavolino
Coffee table
L / W 60 cm - 24 inches
P / D 60 cm - 24 inches
H / H 30 cm - 13 inches

ARTI
Tavolino
Coffee table
L / W 160 cm - 63 inches
P / D 90 cm - 35 inches
H / H 76 cm - 30 inches

OTTOMANS



2043 BA

2043 BF

SHIBUYA



R151



R150

FIOCCO



FIO4

FIO5

FIO9

UNO



UNO5

UNO4

UNO1

2043 BA

Tavolino
Coffee table
L / W 70 cm - 28 inches
P / D 70 cm - 28 inches

2043 BF

Tavolino
Coffee table
L / W 100 cm - 39 inches
P / D 100 cm - 39 inches

R150

Tavolino
Coffee table
L / W 165 cm - 65 inches
P / D 95 cm - 37 inches
H / H 30 cm - 12 inches

R151

Tavolino
Coffee table
L / W 100 cm - 39 inches
P / D 100 cm - 39 inches
H / H 50 cm - 20 inches

FIO4

Tavolino
Coffee table
L / W 45 cm - 18 inches
P / D 45 cm - 18 inches
H / H 46 cm - 18 inches

FIO5

Tavolino
Coffee table
L / W 50 cm - 20 inches
P / D 50 cm - 20 inches
H / H 46 cm - 18 inches

FIO6

Tavolino
Coffee table
L / W 60 cm - 24 inches
P / D 60 cm - 24 inches
H / H 37 cm - 15 inches

FIO9

Tavolino
Coffee table
L / W 90 cm - 35 inches
P / D 90 cm - 35 inches
H / H 30 cm - 12 inches

UNO1

Tavolino
Coffee table
L / W 100 cm - 40 inches
P / D 100 cm - 40 inches
H / H 30 cm - 12 inches

UNO4

Tavolino
Coffee table
L / W 40 cm - 16 inches
P / D 40 cm - 16 inches
H / H 40 cm - 16 inches

UNO5

Tavolino
Coffee table
L / W 50 cm - 20 inches
P / D 50 cm - 20 inches
H / H 35 cm - 14 inches

FINITURE Colori disponibili come da campionario
FINISHING Please refer to the samples box of finishes

FINITURE Colori disponibili come da campionario
FINISHING Please refer to the samples box of finishes

Le dimensioni sono indicative e possono subire modifiche / All dimensions are approximate and for guidance only
Le cuciture nelle versioni in pelle possono variare rispetto alle versioni in tessuto / Stitchings in leather versions may vary compared to fabric ones

CAPRI



S314

Tavolino
Coffee table
L / W 140 cm - 55 inches
P / D 140 cm - 55 inches
H / H 33 cm - 13 inches

C100

Tavolino
Coffee table
L / W 100 cm - 40 inches
P / D 70 cm - 28 inches
H / H 33 cm - 6 inches

C140

Tavolino
Coffee table
L / W 140 cm - 55 inches
P / D 70 cm - 28 inches
H / H 33 cm - 13 inches

FINITURE Colori disponibili come da campionario
FINISHING Please refer to the samples box of finishes

L250 / L130



L250



L130

L250

Madie
Sideboard
L / W 250 cm - 98 inches
P / D 50 cm - 19 inches
H / H 65 cm - 25 inches

L130

Madie
Sideboard
L / W 130 cm - 51 inches
P / D 50 cm - 19 inches
H / H 110 cm - 43 inches

FINITURE Colori disponibili come da campionario
FINISHING Please refer to the samples box of finishes

DOMINO GIRO



TBA

TBA

Madie
Sideboard
L / W 45 cm - 18 inches
P / D 45 cm - 18 inches
H / H 140 cm - 55 inches

FINITURE Colori disponibili come da campionario
FINISHING Please refer to the samples box of finishes

R188



R188

R188

Madie
Sideboard
L / W 192 cm - 76 inches
P / D 51 cm - 20 inches
H / H 140 cm - 55 inches

FINITURE Colori disponibili come da campionario
FINISHING Please refer to the samples box of finishes

A120 / A240



A240



A120

A120

Madie
Sideboard
L / W 120 cm - 47 inches
P / D 53 cm - 21 inches
H / H 120 cm - 47 inches

A240

Madie
Sideboard
L / W 240 cm - 94 inches
P / D 53 cm - 21 inches
H / H 68 cm - 27 inches

FINITURE STRUTTURA Colori disponibili come da campionario
FINISHING STRUCTURE Please refer to the samples box of finishes

TEMPO



000X FC

000X FC

Madie
Sideboard
L / W 212 cm - 84 inches
P / D 57 cm - 22 inches
H / H 68 cm - 27 inches

FINITURE Colori disponibili come da campionario
FINISHING Please refer to the samples box of finishes

CABARET 22B



CABA XA

CABA XA

Madie
Sideboard
L / W 212 cm - 84 inches
P / D 57 cm - 22 inches
H / H 68 cm - 27 inches

FINITURE Colori disponibili come da campionario
FINISHING Please refer to the samples box of finishes